

14-1/2° PRESSURE ANGLE – CATALOG NUMBER / DIMENSIONS

Spur Gears.....	18-27
Change Gears	28-32
Stem Pinions	33
Drawn Pinion Wire.....	34
Rack.....	35
Internal Gears.....	36

20° PRESSURE ANGLE – CATALOG NUMBER / DIMENSIONS

Spur Gears.....	37-46
Rack.....	47
Internal Gears.....	48

Selection Procedure.....	49
Horsepower & Torque Ratings	50-62
Gear Gauges	62
Stock Altered/Custom Spur Gears.....	3-5
Spur Gear Engineering Information.....	306-311

Spur Gears

48 and 32 Diametral Pitch (Brass)

14-1/2° Pressure Angle (will not operate with 20° spurs)

A

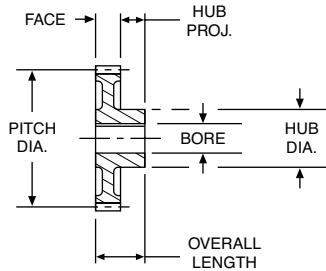

STANDARD TOLERANCES

DIMENSION		TOLERANCE
BORE	All	±.0005



REFERENCE PAGES

Alterations — 322
Lubrication — 322
Materials — 323

ALL DIMENSIONS IN INCHES
ORDER BY CATALOG NUMBER OR ITEM CODE

No. of Teeth	Pitch Dia.	Bore	Hub		Style See Page 323	Without Keyway or Setscrew	
			Dia.	Proj.		Catalog Number	Item Code
48 DIAMETRAL PITCH						Face = .125" Outside Dia. = Pitch Dia. + .042" Overall Length = .125" + Hub Proj.	
BRASS							
10	.208	.0935	-	-	A	G127	09322
12	.250	.125	-	-		G129	09324
14	.292					G130	09326
15	.312					G131	09328
16	.333					G132	09330
18	.375					G133	09332
20	.417					G134	09334
22	.458	.1875	-	-		G135	09336
24	.500					G136	09338
26	.542					G137	09340
32	.667				G138	09342	
36	.750				G139	09344	
40	.833				G140	09346	
44	.917	.250	.50	.25	G141	09348	
48	1.000				G142	09350	
54	1.125				G143	09352	
60	1.250				G144	09354	
66	1.375				G145	09356	
72	1.500				G146	09358	
84	1.750	.3125	.62	.31	G147	09360	
96	2.000				G148	09362	
100	2.083				G154	09364	
120	2.500				G149	09366	
144	3.000				G150	09368	
192	4.000				G151	09370	
32 DIAMETRAL PITCH						Face = .062" Outside Dia. = Pitch Dia. + .062"	
BRASS							
10	.312	.125	-	-	A	G96	09234
14	.438					G98	09238
16	.500	.1875	-	-		G99	09240
20	.625					G101	09244
24	.750					G102	09246
28	.875					G103	09248
32	1.000					G104	09250
40	1.250					.250	-
48	1.500	G106	09254				
64	2.000	.3125	-	-		G110	09256
80	2.500				G111	09258	
96	3.000				G112	09260	
112	3.500				G113	09262	
128	4.000				G114	09264	
Face = .188"							
8	.250	.125	-	-	A	G159	09266
10	.312					G161	09268
12	.375					G163	09270
14	.438					G165	09272
15	.469					G166	09274
16	.500	.1875	-	-		G167	09276
18	.562					G168	09278
20	.625					G169	09280
22	.688					G170	09282
24	.750					G171	09284
26	.812				G172	09286	
28	.875				G173	09288	
30	.938				G174	09290	
32	1.000	.250	-	-	G175	09292	
36	1.125				G176	09294	
40	1.250				G177	09296	
44	1.375				G178	09298	
48	1.500				G179	09300	
52	1.625				G180	09302	
56	1.750	.3125	-	-	G181	09304	

32 and 24 Diametral Pitch (Brass & Steel) 14-1/2° Pressure Angle (will not operate with 20° spurs)

ALL DIMENSIONS IN INCHES
ORDER BY CATALOG NUMBER OR ITEM CODE

No. of Teeth	Pitch Dia.	Bore	Hub		Style See Page 323	Without Keyway or Setscrew		With Setscrew			
			Dia.	Proj.		Catalog Number	Item Code	Catalog Number	Item Code		
32 DIAMETRAL PITCH						Face = .188" Outside Dia. = Pitch Dia. + .062" Overall Length = .187" + Hub Proj.					
BRASS											
64	2.000	.3125	.62	.25	B	G182	09306	-	-		
72	2.250			.31	.31	C	G183	09308	-	-	
80	2.500					.75	.31	D	G184	09310	-
96	3.000			G185	09312			-	-		
112	3.500			G186	09314			-	-		
128	4.000			G187	09316			-	-		
STEEL											
16	.500	.1875	-	-	A	S3216	09572	-	-		
20	.625	.250	-	-		S3220	09574	-	-		
22	.688	.250	-	-		S3222	09576	-	-		
24	.750	.3125	-	-		S3224	09578	-	-		
28	.875	.375	-	-		S3228	09580	-	-		
32	1.000	.375	-	-		S3232	09582	-	-		
40	1.250	.375	-	-		S3240	09584	-	-		
48	1.500					S3248	09586	-	-		
56	1.750					S3256	09588	-	-		
64	2.000					S3264	09590	-	-		
80	2.500					S3280	09592	-	-		
96	3.000					S3296	09594	-	-		
16	.500	.1875	.39	.31		-	-	H3216	09536		
18	.562	.1875	.45	.31		-	-	H3218	09538		
20	.625	.250	.52	.31		-	-	H3220	09540		
22	.688	.250	.58	.31		-	-	H3222	09542		
24	.750	.3125	.64	.31		-	-	H3224	09544		
26	.812		.70			-	-	H3226	09546		
28	.875		.75		-	-	H3228	09548			
30	.938		.75		-	-	H3230	09550			
32	1.000		.75		.38	-	-	H3232	09552		
40	1.250		.375		.88	.38	-	-	H3240	09554	
48	1.500	1.00		.38	-	-	H3248	09556			
56	1.750				-	-	H3256	09558			
64	2.000				-	-	H3264	09560			
80	2.500				1.12	.50	-	-	H3280	09562	
96	3.000				1.25	.50	-	-	H3296	09564	
128	4.000		1.88		.50	-	-	H32128	09566		
160	5.000	2.12	.50	-	-	H32160	09568				
192	6.000	2.12	.50	-	-	H32192	09570				
24 DIAMETRAL PITCH						Face = .250" Outside Dia. = Pitch Dia. + .083" Overall Length = .250" + Hub Proj.					
BRASS											
12	.500	.1875	.38	.25	A	G254	09202	-	-		
16	.667		.50			G256	09204	-	-		
18	.750		.50			G257	09206	-	-		
24	1.000	.250	.62	.25	A	G258	09208	-	-		
30	1.250		.62			G259	09210	-	-		
36	1.500		.62			G261	09212	-	-		
42	1.750		.3125			.62	.25	B	G263	09214	-
48	2.000	.69		.31	C	G264			09216	-	-
54	2.250					.31			.31	G265	09218
60	2.500	G266		09220	-					-	
66	2.750	.375	.38	.38	D	G267	09222	-	-		
72	3.000					.75	G268	09224	-	-	
84	3.500					.75	G269	09226	-	-	
96	4.000					.75	G270	09228	-	-	
120	5.000					.88	G272	09230	-	-	
144	6.000					.88	G274	09232	-	-	

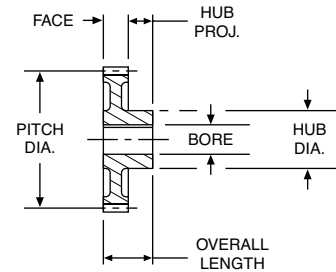

STANDARD TOLERANCES

DIMENSION	TOLERANCE
BORE	All ±.0005



REFERENCE PAGES

- Alterations — 322
- Horsepower Ratings — 50
- Lubrication — 322
- Materials — 323
- Selection Procedure — 49

Spur Gears

24 and 20 Diametral Pitch (Steel)

14-1/2° Pressure Angle (will not operate with 20° spurs)

A

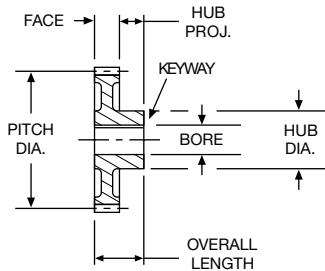

STANDARD TOLERANCES

DIMENSION		TOLERANCE
BORE	All	±.0005



REFERENCE PAGES

- Alterations — 322
- Horsepower Ratings — 50, 51
- Lubrication — 322
- Materials — 323
- Selection Procedure — 49

*Special Pitch Diameter, used for calculating Center Distance only, not Ratio.

†H2412 & H2414 have #35 (.110) drilled hole through one wall, no keyway.

‡H2415-H24144 has one setscrew, no keyway.

**NA11B-5/16"-NA14B-5/16 bore has #35 (.110) drilled hole through one wall, no keyway.

††3/8" & 1/2" bores have one setscrew, no keyway.

NA40-5/8" & NA40-3/4" bores have standard keyway at 90° to setscrew. See Page 323.

ALL DIMENSIONS IN INCHES
ORDER BY CATALOG NUMBER OR ITEM CODE

No. of Teeth	Pitch Dia.	Bore	Hub		Style See Page 323	Without Keyway or Setscrew		With Keyway & Setscrew†	
			Dia.	Proj.		Catalog Number	Item Code	Catalog Number	Item Code
24 DIAMETRAL PITCH						Face = .250" Outside Dia. = Pitch Dia. + .083" Overall Length = .250" + Hub Proj.			
STEEL									
12	.500	.250	-	-	A	S2412	09630	-	-
15	.625		-	-		S2415	09632	-	-
16	.667		-	-		S2416	09634	-	-
18	.750		-	-		S2418	09636	-	-
21	.875	.500	-	-	S2421	09638	-	-	
24	1.000		-	-	S2424	09640	-	-	
30	1.250		-	-	S2430	09642	-	-	
36	1.500		-	-	S2436	09644	-	-	
42	1.750		-	-	S2442	09646	-	-	
48	2.000		-	-	S2448	09648	-	-	
60	2.500		-	-	S2460	09650	-	-	
72	3.000		-	-	S2472	09652	-	-	
12	.500	.250	.36	.31	-	-	H2412†	09596	
14	.583		.46		H2414†	09598			
15	.625		.50		H2415‡	09600			
16	.667		.54		H2416‡	09602			
18	.750	.3125	.62	.31	-	-	H2418‡	09604	
20	.833		.70		H2420‡	09606			
21	.875		.74		H2421‡	09608			
24	1.000		.87		H2424‡	09610			
30	1.250		1.00		H2430‡	09612			
36	1.500		1.12		H2436‡	09614			
42	1.750		1.12		H2442‡	09616			
48	2.000		1.25		H2448‡	09618			
60	2.500	1.25	H2460‡	09620					
72	3.000	.500	1.38	.50	-	-	H2472‡	09622	
96	4.000		2.00		H2496‡	09624			
120	5.000		2.25		H24120‡	09626			
144	6.000		2.25		H24144‡	09628			
20 DIAMETRAL PITCH						Face = .375" Outside Dia. = Pitch Dia. + .100" Overall Length = .375" + Hub Proj.			
STEEL									
11	.600*	.3125	.46	.38	NA11B	09662	NA11B-5/16**	46000	
12	.600		.46		NA12B	09664	NA12B-5/16**	46001	
13	.650		.50		NA13B	09666	NA13B-5/16**	46002	
14	.700		.56		NA14B	09668	NA14B-5/16**	46003	
15	.750	.375	.60	.38	NA15B	09670	NA15B-3/8††	46004	
16	.800		.66		NA16B	09672	NA16B-3/8††	46005	
18	.900		.74		NA18B	09674	NA18B-3/8††	46006	
20	1.000	.500	.84	.38	NA20B	09676	NA20B-3/8††	46007	
								NA20B-1/2††	46008
22	1.100	.500	.82	.38	NA22B	09678	NA22B-3/8††	46009	
								NA22B-1/2††	46010
24	1.200	.500	.92	.38	NA24	09680	NA24-3/8††	46011	
								NA24-1/2††	46012
25	1.250	.500	.97	.38	NA25B	09682	NA25B-3/8††	46013	
								NA25B-1/2††	46014
28	1.400	.500	1.12	.38	NA28B	09684	NA28B-3/8††	46015	
								NA28B-1/2††	46016
30	1.500	.500	1.22	.38	NA30B	09686	NA30B-3/8††	46017	
								NA30B-1/2††	46018
32	1.600	.500	1.32	.50	NA32	09688	NA32-3/8††	46019	
								NA32-1/2††	46020
35	1.750	.500	1.47	.50	NA35	09690	NA35-3/8††	46021	
								NA35-1/2††	46022
36	1.800	.500	1.52	.50	NA36	09692	NA36-3/8††	46023	
								NA36-1/2††	46024
40	2.000	.375	1.72	.50	NA40	09694	NA40-3/8††	46025	
			.500					NA40-1/2††	46026
			.625					NA40-5/8	46027
			.750					NA40-3/4	46028
48	2.400	.375	1.33	.50	NA48A	10208	-	-	
50	2.500		1.42		NA50A	10210	-	-	
60	3.000		1.92		NA60A	10212	-	-	
64	3.200		2.12		NA64A	10214	-	-	

20 and 16 Diametral Pitch (Cast Iron, Brass & Steel)

14-1/2° Pressure Angle (will not operate with 20° spurs)

ALL DIMENSIONS IN INCHES
ORDER BY CATALOG NUMBER OR ITEM CODE

No. of Teeth	Pitch Dia.	Bore	Hub		Style See Page 323	Without Keyway or Setscrew		With Keyway and Setscrew†					
			Dia.	Proj.		Catalog Number	Item Code	Catalog Number	Item Code				
20 DIAMETRAL PITCH						Face = .375" Outside Dia. = Pitch Dia. + .100" Overall Length = .375" + Hub Proj.							
CAST IRON													
70	3.500	.375	1.25	.50	B	NA70	10216	-	-				
72	3.600					NA72	10218	-	-				
80	4.000					NA80	10220	-	-				
84	4.200					NA84	10222	-	-				
90	4.500	.500	1.25	.50	C	NA90	10224	-	-				
96	4.800					NA96	10226	-	-				
100	5.000					NA100	10228	-	-				
112	5.600					NA112	10230	-	-				
120	6.000	.500	1.50	.50	D	NA120	10232	-	-				
140	7.000					NA140	10234	-	-				
144	7.200					NA144	10236	-	-				
160	8.000					NA160	10238	-	-				
180	9.000					NA180	10240	-	-				
200	10.000					NA200B	10242	-	-				
16 DIAMETRAL PITCH						Face = .313" Outside Dia. = Pitch Dia. + .125" Overall Length = Face + Hub Proj.							
BRASS													
8	.500	.1875	-	-	A	G226	09168	-	-				
9	.563					G227	09170	-	-				
10	.625					G228	09172	-	-				
12	.750					G229	09174	-	-				
14	.875	.250	-	-	A	G230	09176	-	-				
16	1.000					G231	09178	-	-				
18	1.125					G232	09180	-	-				
20	1.250					G233	09182	-	-				
24	1.500	.3125	-	-	A	G235	09184	-	-				
28	1.750					G236	09186	-	-				
32	2.000					G237	09188	-	-				
40	2.500					G238	09190	-	-				
48	3.000	.3125	.75	.31	B	G239	09192	-	-				
56	3.500					.375	1.00	.38	D	G240	09194	-	-
64	4.000									G241	09196	-	-
80	5.000									G242	09198	-	-
STEEL Face = .500"													
11	.750*	.375	.56	.44	A	NB11B	09704	NB11B-3/8†	46029				
12	.750					NB12B	09706	NB12B-3/8†	46030				
13	.813					NB13B	09708	NB13B-3/8†	46031				
14	.875					NB14B	09710	NB14B-3/8†	46032				
15	.938	.500	.75	.44	A	NB15B	09712	NB15B-1/2†	46033				
16	1.000					NB16B	09714	NB16B-1/2†	46034				
18	1.125					NB18B	09716	NB18B-1/2†	46035				
20	1.250					NB20B	09718	NB20B-1/2†	46036				
			.625	.96		-	NB20B-5/8	46037					
22	1.375	.500	1.08	.44	A	NB22B	09720	NB22B-1/2†	46038				
							.625			-	NB22B-5/8	46039	
24	1.500					.500	1.20	.44	A	NB24B	09722	NB24B-1/2†	46040
											.625		
			.750							-	NB24B-3/4	46042	
26	1.625	.500	1.33	.44	A					NB26B	09724	NB26B-1/2†	46043
							.625			-	NB26B-5/8	46044	
							.750			-	NB26B-3/4	46045	
28	1.750					.500	1.45	.50	A	NB28B	09726	NB28B-1/2†	46046
			.625							-	NB28B-5/8	46047	
			.750							-	NB28B-3/4	46048	
			.875							-	NB28B-7/8	46049	
30	1.875	.500	1.58	.50	A	NB30B	09728	NB30B-1/2†	46050				
							.625			-	NB30B-5/8	46051	
							.750			-	NB30B-3/4	46052	
							.875			-	NB30B-7/8	46053	
		1.000				-	NB30B-1	46054					

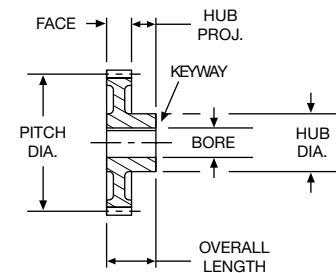
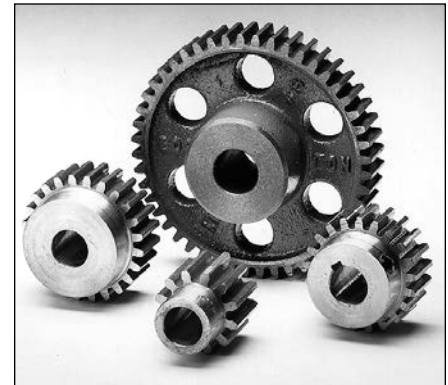

STANDARD TOLERANCES

DIMENSION	TOLERANCE
BORE	All ±.0005



REFERENCE PAGES

- Alterations — 322
- Horsepower Ratings — 51, 52
- Lubrication — 322
- Materials — 323
- Selection Procedure — 49

*Special Pitch Diameter, used for calculating Center Distance only, not Ratio.

†3/8" and 1/2" bores have one setscrew, no keyway. 5/8" bore and larger have standard keyway at 90° to setscrew. See Page 323.

Spur Gears

16 and 12 Diametral Pitch (Steel, Non-Metallic & Cast Iron)

14-1/2° Pressure Angle (will not operate with 20° spurs)

A

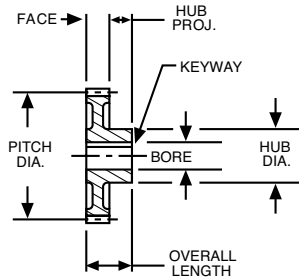

STANDARD TOLERANCES

DIMENSION		TOLERANCE
BORE	All	±.0005



REFERENCE PAGES

- Alterations — 322
- Horsepower Ratings — 52, 53
- Lubrication — 322
- Materials — 323
- Selection Procedure — 49

*Special Pitch Diameter, used for calculating Center Distance only, not Ratio.

†1/2" bore has one setscrew, no keyway.

5/8" bore and larger have standard keyway at 90° to setscrew. See Page 323.

ALL DIMENSIONS IN INCHES
ORDER BY CATALOG NUMBER OR ITEM CODE

No. of Teeth	Pitch Dia.	Bore	Hub		Style See Page 323	Without Keyway or Setscrew		With Keyway and Setscrew†			
			Dia.	Proj.		Catalog Number	Item Code	Catalog Number	Item Code		
16 DIAMETRAL PITCH											
						Face = .500" Outside Dia. = Pitch Dia. + .125" Overall Length = .500" + Hub Proj.					
STEEL											
32	2.000	.500 .625 .750 .875 1.000	1.70	.50	A	NB32	09730	NB32-1/2†	46055		
						-	-	NB32-5/8	46056		
						-	-	NB32-3/4	46057		
						-	-	NB32-7/8	46058		
						-	-	NB32-1	46059		
36	2.250	.500	1.95	.50		NB36	09732	-	-		
40	2.500	.500	1.69			NB40A	10244	-	-		
48	3.000	.500	2.19			NB48A	10246	-	-		
NON-METALLIC											
16	1.000	.375	.81	.50		QBH16	09014	-	-		
20	1.250	.375	1.06			QBH20	09018	-	-		
24	1.500	.500	1.31	.50	A	QBH24	09022	-	-		
32	2.000		1.81			QBH32	09024	-	-		
40	2.500		-			QB40	09000	-	-		
48	3.000		-			QB48	09002	-	-		
64	4.000		-			QB64	09006	-	-		
CAST IRON											
54	3.375	.500	1.25	.50	B	NB54	10248	-	-		
56	3.500		1.25			NB56	10250	-	-		
60	3.750		1.38			NB60	10252	-	-		
64	4.000	.625	1.38	.62	C	NB64	10254	-	-		
72	4.500		1.38			NB72	10256	-	-		
80	5.000		1.50			NB80	10258	-	-		
84	5.250		1.50			NB84	10260	-	-		
96	6.000		1.50			NB96	10262	-	-		
112	7.000		1.50		NB112	10264	-	-			
120	7.500		1.50		NB120	10266	-	-			
128	8.000		1.50		NB128	10268	-	-			
144	9.000		1.75		1.75	.75	D	NB144	10270	-	-
160	10.000		1.75					NB160B	10272	-	-
192	12.000	2.00	NB192B	10274				-	-		
12 DIAMETRAL PITCH											
						Face = .750" Outside Dia. = Pitch Dia. + .167" Overall Length = .750" + Hub Proj.					
STEEL											
11	1.000*	.500	.75	.50		ND11B	09744	ND11B-1/2†	46060		
12	1.000		.75			ND12B	09746	ND12B-1/2†	46061		
13	1.083		.83			ND13B	09748	ND13B-1/2†	46062		
14	1.167		.92			ND14B	09750	ND14B-1/2†	46063		
15	1.250	.625	1.00	.50		ND15B	09752	ND15B-5/8	46064		
16	1.333		.99			ND16B	09754	ND16B-5/8	46065		
18	1.500		1.15			ND18B	09756	ND18B-5/8	46066		
20	1.667	.625 .750	1.32	.50		ND20B	09758	ND20B-5/8	46067		
							-	-	ND20B-3/4	46068	
21	1.750	.625 .750 .875	1.40	.50	A	ND21B	09760	ND21B-5/8	46069		
							-	-	ND21B-3/4	46070	
							-	-	ND21B-7/8	46071	
22	1.833	.625 .750 .875 1.000	1.49	.50		ND22B	09762	ND22B-5/8	46072		
							-	-	ND22B-3/4	46073	
							-	-	ND22B-7/8	46074	
							-	-	ND22B-1	46075	
24	2.000	.625 .750 .875 1.000	1.65	.50		ND24B	09764	ND24B-5/8	46076		
							-	-	ND24B-3/4	46077	
							-	-	ND24B-7/8	46078	
							-	-	ND24B-1	46079	
30	2.500	.625	2.15	.62		ND30	09766	-	-		
32	2.667		1.92			ND32A	10276	-	-		
36	3.000		2.25			ND36A	10278	-	-		
40	3.333		2.34			ND40A	10280	-	-		
42	3.500		2.50			ND42A	10282	-	-		

12 and 10 Diametral Pitch (Steel, Non-Metallic & Cast Iron)

14-1/2° Pressure Angle (will not operate with 20° spurs)

ALL DIMENSIONS IN INCHES
ORDER BY CATALOG NUMBER OR ITEM CODE

No. of Teeth	Pitch Dia.	Bore	Hub		Style See Page 323	Without Keyway or Setscrew		With Keyway and Setscrew†	
			Dia.	Proj.		Catalog Number	Item Code	Catalog Number	Item Code
12 DIAMETRAL PITCH						Face = .750" Outside Dia. = Pitch Dia. + .167" Overall Length = .750" + Hub Proj.			
NON-METALLIC									
15	1.250		1.00		A	QDH15	09038	-	-
18	1.500	.500	1.25	.50		QDH18	09042	-	-
21	1.750		1.50			QDH21	09046	-	-
24	2.000		1.75	.50		QDH24	09050	-	-
30	2.500	.625	2.25			QDH30	09052	-	-
36	3.000		-	-		QD36	09026	-	-
48	4.000		-	-	QD48	09030	-	-	
60	5.000	.750	-	-	QD60	09034	-	-	
CAST-IRON									
48	4.000				C	ND48	10284	-	-
54	4.500					ND54	10286	-	-
60	5.000	.750	1.75	.75		ND60	10288	-	-
64	5.333					ND64	10290	-	-
72	6.000					ND72	10292	-	-
84	7.000					ND84	10294	-	-
96	8.000				D	ND96	10296	-	-
108	9.000	.750	2.00	.75		ND108	10298	-	-
112	9.333					ND112	10300	-	-
120	10.000					ND120	10302	-	-
144	12.000	.875	2.00	1.00		ND144	10304	-	-
168	14.000					ND168	10306	-	-
10 DIAMETRAL PITCH						Face = 1.000" Outside Dia. = Pitch Dia. + .200" Overall Length = 1.000" + Hub Proj.			
STEEL									
11	1.200*		.92	.62	A	NF11B	09778	NF11B-5/8	46080
12	1.200	.625	.92			NF12B	09780	NF12B-5/8	46081
14	1.400		1.02			NF14B	09782	NF14B-5/8	46082
15	1.500	.750	1.12	.62		NF15B	09784	NF15B-3/4	46083
16	1.600		1.22			NF16B	09786	NF16B-3/4	46084
18	1.800	.750	1.42	.62		NF18B	09788	NF18B-3/4	46085
		.875				-	-	NF18B-7/8	46086
20	2.000	.750	1.62	.62		NF20B	09790	NF20B-3/4	46087
		.875				-	-	NF20B-7/8	46088
		1.000				-	-	NF20B-1	46089
24	2.400	.750	2.02	.62		NF24B	09792	NF24B-3/4	46090
		.875				-	-	NF24B-7/8	46091
		1.000				-	-	NF24B-1	46092
25	2.500	.750	2.12	.62		NF25	09794	-	-
28	2.800		1.81			NF28A	10310	-	-
30	3.000		2.02			NF30A	10312	-	-
32	3.200	.750	2.22	.88		NF32A	10314	-	-
35	3.500		2.52			NF35A	10316	-	-
36	3.600		2.61		NF36A	10318	-	-	
NON-METALLIC									
15	1.500	.625	1.20	.62	A	QFH15	09062	-	-
18	1.800		1.50			QFH18	09066	-	-
20	2.000		1.70			QFH20	09068	-	-
25	2.500	.750	2.20	.62		QFH25	09070	-	-
30	3.000		2.70			QFH30	09072	-	-

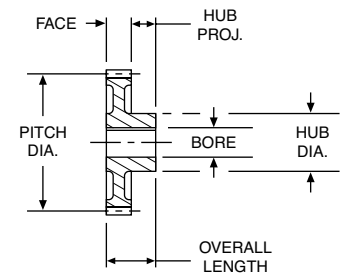

STANDARD TOLERANCES

DIMENSION	TOLERANCE
BORE	All ±.0005

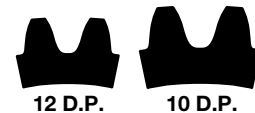

REFERENCE PAGES

- Alterations — 322
- Horsepower Ratings — 53, 54
- Lubrication — 322
- Materials — 323
- Selection Procedure — 49

*Special Pitch Diameter, used for calculating Center Distance only, not Ratio.

†All gears have standard keyway at 90° to setscrew. See Page 323.

Spur Gears

10 and 8 Diametral Pitch (Cast Iron, Steel & Non-Metallic)

14-1/2° Pressure Angle (will not operate with 20° spurs)

A

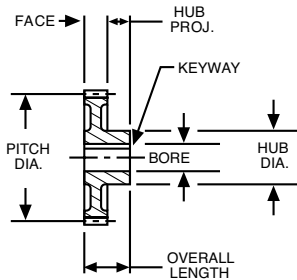

STANDARD TOLERANCES

DIMENSION		TOLERANCE
BORE	All	±.0005

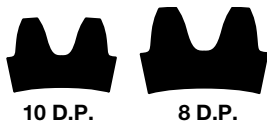

REFERENCE PAGES

- Alterations — 322
- Horsepower Ratings — 54, 55
- Lubrication — 322
- Materials — 323
- Selection Procedure — 49

*Special Pitch Diameter, used for calculating Center Distance only, not Ratio.

†All gears have standard keyway, at 90° to setscrew. See Page 323.

ALL DIMENSIONS IN INCHES
ORDER BY CATALOG NUMBER OR ITEM CODE

No. of Teeth	Pitch Dia.	Bore	Hub		Style See Page 323	Without Keyway or Setscrew		With Keyway and Setscrew†					
			Dia.	Proj.		Catalog Number	Item Code	Catalog Number	Item Code				
10 DIAMETRAL PITCH						Face = 1.000" Outside Dia. = Pitch Dia. + .200" Overall Length = 1.000" + Hub Proj.							
CAST IRON													
40	4.000	.875	2.12	.88	B	NF40	10320	-	-				
42	4.200					NF42	10322	-	-				
45	4.500					NF45	10324	-	-				
48	4.800					NF48	10326	-	-				
50	5.000					NF50	10328	-	-				
54	5.400					NF54	10330	-	-				
55	5.500					NF55	10332	-	-				
60	6.000					NF60	10334	-	-				
64	6.400					NF64	10336	-	-				
70	7.000					NF70	10338	-	-				
72	7.200					NF72	10340	-	-				
80	8.000					NF80	10342	-	-				
84	8.400					NF84	10344	-	-				
90	9.000					NF90	10346	-	-				
96	9.600					NF96	10348	-	-				
100	10.000					1.00	2.50	1.00	D	NF100	10350	-	-
110	11.000	NF110	10352	-	-								
120	12.000	NF120	10356	-	-								
140	14.000	NF140	10358	-	-								
144	14.400	NF144	10360	-	-								
160	16.000	NF160	10362	-	-								
180	18.000	NF180	10364	-	-								
8 DIAMETRAL PITCH										Face = 1.250" Outside Dia. = Pitch Dia. + .250" Overall Length = 1.250" + Hub Proj.			
STEEL													
11	1.500*	.750	1.12	.75	A					NH11B	09806	NH11B-3/4	46093
12	1.500					NH12B	09808	NH12B-3/4	46094				
14	1.750					NH14B	09810	NH14B-3/4	46095				
15	1.875					NH15B	09812	NH15B-7/8	46096				
16	2.000					.875 1.000	1.56	.75	NH16B	09814	NH16B-7/8	46097	
									-	-	NH16B-1	46098	
18	2.250					.875 1.000 1.125	1.81	.75	NH18B	09816	NH18B-7/8	46099	
									-	-	NH18B-1	46100	
									-	-	NH18B-1-1/8	46101	
20	2.500					.875 1.000 1.125	2.06	.75	NH20B	09818	NH20B-7/8	46102	
									-	-	NH20B-1	46103	
22	2.750					.875 1.000 1.125	2.31	.75	-	-	NH20B-1-1/8	46104	
									NH22B	09820	NH22B-7/8	46105	
									-	-	NH22B-1	46106	
24	3.000					.875	2.06	.88	-	-	NH22B-1-1/8	46107	
		NH24A	10368	-	-								
28	3.500	1.000	3.00	.88	NH28A	10370	-	-					
30	3.750				NH30A	10372	-	-					
32	4.000				NH32A	10374	-	-					
					NON-METALLIC								
16	2.000	.750	1.62	.75	A	QHH16	09082	-	-				
18	2.250					QHH18	09084	-	-				
20	2.500					QHH20	09086	-	-				
24	3.000					QHH24	09088	-	-				
28	3.500					QHH28	09090	-	-				
						-	-	-	-				

8 and 6 Diametral Pitch (Cast Iron & Steel)

14-1/2° Pressure Angle (will not operate with 20° spurs)

ALL DIMENSIONS IN INCHES
ORDER BY CATALOG NUMBER OR ITEM CODE

No. of Teeth	Pitch Dia.	Bore	Hub		Style See Page 323	Without Keyway or Setscrew		With Keyway and Setscrew†				
			Dia.	Proj.		Catalog Number	Item Code	Catalog Number	Item Code			
8 DIAMETRAL PITCH						Face = 1.250" Outside Dia. = Pitch Dia. + .250" Overall Length = 1.250" + Hub Proj.						
CAST IRON												
36	4.500	1.000	2.50	1.00	B	NH36	10376	-	-			
40	5.000					NH40	10378	-	-			
42	5.250					NH42	10380	-	-			
44	5.500					NH44	10382	-	-			
48	6.000					NH48	10384	-	-			
54	6.750					NH54	10386	-	-			
56	7.000					NH56	10388	-	-			
60	7.500				NH60	10390	-	-				
64	8.000				NH64	10392	-	-				
72	9.000				NH72	10394	-	-				
80	10.000				1.125	3.00	1.12	D	NH80	10396	-	-
84	10.500								NH84	10398	-	-
88	11.000								NH88	10400	-	-
96	12.000								NH96	10402	-	-
112	14.000	NH112	10404	-					-			
120	15.000	NH120	10406	-					-			
128	16.000	NH128	10408	-					-			
144	18.000	NH144	10410	-					-			
160	20.000	NH160B	10412	-					-			
6 DIAMETRAL PITCH									Face = 1.500" Outside Dia. = Pitch Dia + .333" Overall Length = 1.500" + Hub Proj.			
STEEL												
11	2.000*	1.000	1.46	.88	A	NJ11B	09830	NJ11B-1	46108			
12	2.000					NJ12B	09832	NJ12B-1	46109			
14	2.333	1.000	1.79	.88		NJ14B	09834	NJ14B-1	46110			
		1.125				-	NJ14B-1-1/8	46111				
		1.250				-	-	-				
15	2.500	1.000	1.96	.88		NJ15B	09836	NJ15B-1	46112			
		1.125				-	NJ15B-1-1/8	46113				
		1.1875				-	NJ15B-1-3/16	46114				
		1.250				-	NJ15B-1-1/4	46115				
16	2.667	1.000	2.13	.88		NJ16B	09838	NJ16B-1	46116			
		1.125				-	NJ16B-1-1/8	46117				
		1.1875				-	NJ16B-1-3/16	46118				
		1.250				-	NJ16B-1-1/4	46119				
18	3.000	1.000	2.46	.88		NJ18B	09840	NJ18B-1	46120			
		1.125				-	NJ18B-1-1/8	46121				
		1.1875				-	NJ18B-1-3/16	46122				
		1.250				-	NJ18B-1-1/4	46123				
20	3.333	1.000	2.79	.88		NJ20	09842	NJ20-1	46124			
		1.125				-	NJ20-1-1/8	46125				
		1.1875				-	NJ20-1-3/16	46126				
		1.250			-	NJ20-1-1/4	46127					
21	3.500	1.000	2.96	.88	NJ21B	09844	-	-				
24	4.000	1.125	3.00	.88	NJ24A	10414	-	-				
27	4.500		3.50		NJ27A	10416	-	-				
30	5.000		4.00		NJ30A	10418	-	-				

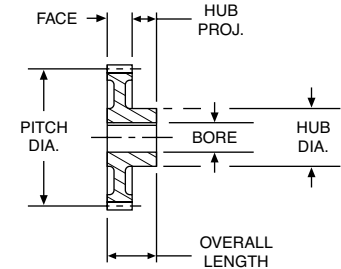

STANDARD TOLERANCES

DIMENSION	TOLERANCE
BORE	All ±.0005

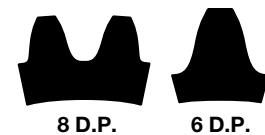

REFERENCE PAGES

- Alterations — 322
- Horsepower Ratings — 55, 56
- Lubrication — 322
- Materials — 323
- Selection Procedure — 49

*Special Pitch Diameter, used for calculating Center Distance only, not Ratio.

†All gears have standard keyway, at 90° to setscrew. See Page 323.

Spur Gears

6 and 5 Diametral Pitch (Steel & Cast Iron)

14-1/2° Pressure Angle (will not operate with 20° spurs)

A

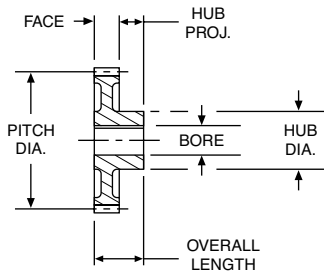

STANDARD TOLERANCES

DIMENSION		TOLERANCE
BORE	All	±.0005

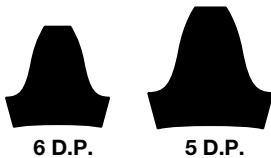

ALL DIMENSIONS IN INCHES
ORDER BY CATALOG NUMBER OR ITEM CODE

No. of Teeth	Pitch Dia.	Bore	Hub		Style See Page 323	Without Keyway or Setscrew	
			Dia.	Proj.		Catalog Number	Item Code
6 DIAMETRAL PITCH						Face = 1.500" Outside Dia. = Pitch Dia. + .333" Overall Length = 1.500" + Hub Proj.	
CAST IRON							
32	5.333	1.125	2.50	1.00	B	NJ32	10420
33	5.500					NJ33	10422
36	6.000					NJ36	10424
40	6.667					NJ40	10426
42	7.000					NJ42	10428
48	8.000					NJ48	10430
54	9.000					NJ54	10432
60	10.000	1.250	3.00	1.25	D	NJ60	10434
64	10.667					NJ64	10436
66	11.000					NJ66	10438
72	12.000					NJ72	10440
84	14.000		3.25	1.50		NJ84	10442
96	16.000					NJ96	10444
108	18.000		3.50	1.50		NJ108	10446
120	20.000					NJ120B	10448
144	24.000					NJ144B	10452
5 DIAMETRAL PITCH						Face = 1.750" Outside Dia. = Pitch Dia. + .400" Overall Length = 1.750" + Hub Proj.	
STEEL							
11	2.400*	1.0625	1.78	.88	A	NK11B	09846
12	2.400					NK12B	09848
14	2.800					NK14B	09850
15	3.000					NK15B	09852
16	3.200					NK16B	09854
18	3.600					NK18B	09856
20	4.000					NK20B	09858
CAST IRON							
24	4.800	1.0625	3.00	1.25	A	NK24B	10454
25	5.000					NK25B	10456
30	6.000					NK30B	10458
35	7.000	1.1875	3.00	1.25	B	NK35B	10460
40	8.000					NK40B	10462
45	9.000					NK45B	10464
50	10.000	1.1875	3.50	1.25	D	NK50B	10466
55	11.000					NK55B	10468
60	12.000					NK60B	10470
70	14.000					NK70B	10472
80	16.000					NK80B	10474
100	20.000					1.3125	3.75

*Special Pitch Diameter, used for calculating Center Distance only, not Ratio.

REFERENCE PAGES

- Alterations — 322
- Horsepower Ratings — 56
- Lubrication — 322
- Materials — 323
- Selection Procedure — 49

4 and 3 Diametral Pitch (Steel & Cast Iron)

14-1/2° Pressure Angle (will not operate with 20° spurs)

ALL DIMENSIONS IN INCHES
ORDER BY CATALOG NUMBER OR ITEM CODE

No. of Teeth	Pitch Dia.	Bore	Hub		Style See Page 323	Without Keyway or Setscrew					
			Dia.	Proj.		Catalog Number	Item Code				
4 DIAMETRAL PITCH											
						Face = 2.000" Outside Dia. = Pitch Dia. + .500" Overall Length = 2.000" + Hub Proj.					
STEEL											
11	3.000*	1.125	2.27	.88	A	NL11B	09860				
12	3.000		2.27			NL12B	09862				
14	3.500		2.77			NL14B	09864				
15	3.750		3.02			NL15B	09866				
16	4.000		3.27			NL16B	09868				
18	4.500		3.77			NL18B	09870				
20	5.000		4.27			NL20B	09872				
22	5.500		4.77			NL22B	09874				
CAST IRON											
24	6.000		1.125			3.50	1.50	A	NL24B	10484	
28	7.000	NL28B		10486							
30	7.500	NL30		10488							
32	8.000	NL32B		10490							
36	9.000	NL36B		10492							
40	10.000	4.00		NL40B	10494						
42	10.500			NL42	10496						
44	11.000			NL44B	10498						
48	12.000			NL48B	10500						
54	13.500			NL54	10502						
56	14.000	1.250	4.00	1.50	NL56B	10504					
60	15.000				NL60	10506					
64	16.000				NL64B	10508					
72	18.000				NL72B	10510					
80	20.000				1.375	4.50	1.50	NL80B	10512		
84	21.000							NL84	10514		
88	22.000							NL88B	10516		
96	24.000							NL96B	10518		
3 DIAMETRAL PITCH											
						Face = 3.000"† Outside Dia. = Pitch Dia. + .667" Overall Length = Face + Hub Proj.					
STEEL											
11	4.000*	1.3125	-	-	A	NO11B†	09876				
12	4.000					NO12B†	09878				
14	4.667					NO14B	09880				
15	5.000					NO15B	09882				
16	5.333					NO16B	09884				
18	6.000					NO18B	09886				
20	6.667					NO20	09888				
21	7.000					NO21B	09890				
CAST IRON											
24	8.000					1.4375	4.50	1.25	B	NO24B	10524
30	10.000	5.25	1.75	NO30B	10526						
36	12.000		5.25	1.75	C		NO36B	10528			
42	14.000	NO42					10530				
48	16.000	1.5625	5.25	1.75	D		NO48B	10532			
60	20.000						NO60B	10536			
72	24.000	1.6875	5.50	1.75	D		NO72B	10538			
84	28.000		5.75				NO84B	10540			
96	32.000	1.9375	5.75	1.75	D		NO96B	10542			
108	36.000						NO108B	10544			

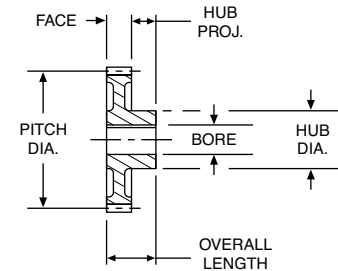

STANDARD TOLERANCES

DIMENSION	TOLERANCE
BORE	All ±.0005

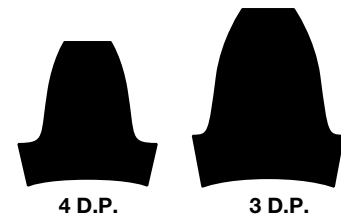

REFERENCE PAGES

- Alterations — 322
- Horsepower Ratings — 56, 57
- Lubrication — 322
- Materials — 323
- Selection Procedure — 49

*Special Pitch Diameter, used for calculating Center Distance only, not Ratio.
†NO11B and NO12B have 4" Face.

Change Gears

20 Diametral Pitch (Steel & Cast Iron)

14-1/2° Pressure Angle (will not operate with 20° spurs)

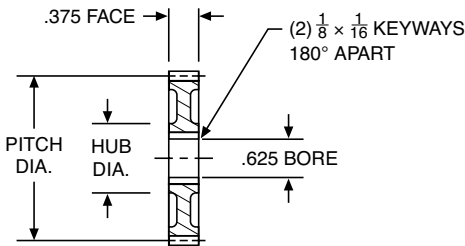

REFERENCE PAGES

- Alterations — 322
- Horsepower Ratings — 51
- Lubrication — 322
- Materials — 323
- Selection Procedure — 49



COMPOUND STEEL BUSHINGS

These steel bushings have 2 keys, 180° apart and fit bores of GA series change gears with a slip fit. They are used to mount two gears on one shaft (or stud) and drive one from the other.

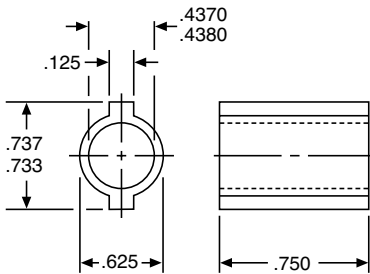

ORDER BY CATALOG NUMBER OR ITEM CODE

CATALOG NO.	ITEM CODE
GAB20A	18500

ALL DIMENSIONS IN INCHES
ORDER BY CATALOG NUMBER OR ITEM CODE

No. of Teeth	Pitch Dia.	Hub Dia.	Catalog Number	Item Code	No. of Teeth	Pitch Dia.	Hub Dia.	Catalog Number	Item Code
20 DIAMETRAL PITCH									
STEEL					CAST IRON				
Outside Dia. = Pitch Dia. + .100"									
20	1.000		GA20	10038	71	3.550		GA71B	10842
21	1.050		GA21	10040	72	3.600		GA72B	10844
22	1.100		GA22	10042	73	3.650		GA73B	10846
23	1.150		GA23	10044	74	3.700		GA74B	10848
24	1.200		GA24	10046	75	3.750	1.56	GA75B	10850
25	1.250		GA25	10048	76	3.800		GA76B	10852
26	1.300		GA26	10050	77	3.850		GA77B	10854
27	1.350		GA27	10052	78	3.900		GA78B	10856
28	1.400		GA28	10054	79	3.950		GA79B	10858
29	1.450		GA29	10056	80	4.000		GA80B	10860
30	1.500		GA30	10058	81	4.050		GA81B	10862
31	1.550		GA31	10060	82	4.100		GA82B	10864
32	1.600		GA32	10062	83	4.150		GA83B	10866
33	1.650		GA33	10064	84	4.200		GA84B	10868
34	1.700		GA34	10066	85	4.250		GA85B	10870
35	1.750		GA35	10068	86	4.300		GA86B	10872
36	1.800		GA36	10070	87	4.350		GA87B	10874
37	1.850		GA37	10072	88	4.400		GA88B	10876
38	1.900		GA38	10074	89	4.450		GA89B	10878
39	1.950		GA39	10076	90	4.500		GA90B	10880
40	2.000		GA40	10078	91	4.550		GA91B	10882
41	2.050		GA41	10080	92	4.600		GA92B	10884
42	2.100		GA42	10082	93	4.650		GA93B	10886
43	2.150		GA43	10084	94	4.700		GA94B	10888
44	2.200		GA44	10086	95	4.750		GA95B	10890
45	2.250		GA45	10088	96	4.800		GA96B	10892
46	2.300		GA46	10090	97	4.850		GA97B	10894
47	2.350		GA47	10092	98	4.900	1.69	GA98B	10896
48	2.400		GA48	10094	99	4.950		GA99B	10898
49	2.450		GA49	10096	100	5.000		GA100B	10900
50	2.500		GA50	10098	101	5.050		GA101B	10902
CAST IRON					102	5.100		GA102B	10904
51	2.550		GA51B	10802	103	5.150		GA103B	10906
52	2.600		GA52B	10804	104	5.200		GA104B	10908
53	2.650		GA53B	10806	105	5.250		GA105B	10910
54	2.700		GA54B	10808	106	5.300		GA106B	10912
55	2.750		GA55B	10810	107	5.350		GA107B	10914
56	2.800		GA56B	10812	108	5.400		GA108B	10916
57	2.850		GA57B	10814	109	5.450		GA109B	10918
58	2.900	1.38	GA58B	10816	110	5.500		GA110B	10920
59	2.950		GA59B	10818	111	5.550		GA111B	10922
60	3.000		GA60B	10820	112	5.600		GA112B	10924
61	3.050		GA61B	10822	113	5.650		GA113B	10926
62	3.100		GA62B	10824	114	5.700		GA114B	10928
63	3.150		GA63B	10826	115	5.750		GA115B	10930
64	3.200		GA64B	10828	116	5.800		GA116B	10932
65	3.250		GA65B	10830	117	5.850		GA117B	10934
66	3.300		GA66B	10832	118	5.900		GA118B	10936
67	3.350	1.56	GA67B	10834	119	5.950		GA119B	10938
68	3.400		GA68B	10836	120	6.000		GA120B	10940
69	3.450		GA69B	10838					
70	3.500		GA70B	10840					

Style See Page 323	20 – 78 Teeth – A 79 – 120 Teeth – C
--------------------	---

16 Diametral Pitch (Steel & Cast Iron)

14-1/2° Pressure Angle (will not operate with 20° spurs)

ALL DIMENSIONS IN INCHES
ORDER BY CATALOG NUMBER OR ITEM CODE

No. of Teeth	Pitch Dia.	Hub Dia.	Catalog Number	Item Code	No. of Teeth	Pitch Dia.	Hub Dia.	Catalog Number	Item Code
16 DIAMETRAL PITCH									
Outside Dia. = Pitch Dia. + .125"									
STEEL					CAST IRON				
20	1.250		GB20	10100	76	4.750		GB76B	11012
21	1.313		GB21	10102	77	4.813		GB77B	11014
22	1.375		GB22	10104	78	4.875		GB78B	11016
23	1.438		GB23	10106	79	4.938		GB79B	11018
24	1.500		GB24	10108	80	5.000		GB80B	11020
25	1.563		GB25	10110	81	5.063		GB81B	11022
26	1.625		GB26	10112	82	5.125		GB82A	11024
27	1.688		GB27	10114	83	5.188		GB83A	11026
28	1.750		GB28	10116	84	5.250		GB84A	11028
29	1.813		GB29	10118	85	5.313		GB85A	11030
30	1.875	-	GB30	10120	86	5.375		GB86A	11032
31	1.938		GB31	10122	87	5.438		GB87A	11034
32	2.000		GB32	10124	88	5.500		GB88A	11036
33	2.063		GB33	10126	89	5.563		GB89A	11038
34	2.125		GB34	10128	90	5.625		GB90A	11040
35	2.188		GB35	10130	91	5.688		GB91A	11042
36	2.250		GB36	10132	92	5.750		GB92A	11044
37	2.313		GB37	10134	93	5.813		GB93A	11046
38	2.375		GB38	10136	94	5.875		GB94A	11048
39	2.438		GB39	10138	95	5.938		GB95A	11050
40	2.500		GB40	10140	96	6.000		GB96A	11052
CAST IRON					97	6.063		GB97A	11054
41	2.563		GB41B	10942	98	6.125		GB98A	11056
42	2.625		GB42B	10944	99	6.188		GB99A	11058
43	2.688		GB43B	10946	100	6.250		GB100A	11060
44	2.750		GB44B	10948	101	6.313	1.81	GB101A	11062
45	2.913		GB45B	10950	102	6.375		GB102A	11064
46	2.875	1.56	GB46B	10952	103	6.438		GB103A	11066
47	2.938		GB47B	10954	104	6.500		GB104A	11068
48	3.000		GB48B	10956	105	6.563		GB105A	11070
49	3.063		GB49B	10958	106	6.625		GB106A	11072
50	3.125		GB50B	10960	107	6.688		GB107A	11074
51	3.188		GB51B	10962	108	6.750		GB108A	11076
52	3.250		GB52B	10964	109	6.913		GB109A	11078
53	3.313		GB53B	10966	110	6.975		GB110A	11080
54	3.375		GB54B	10968	111	6.938		GB111A	11082
55	3.438		GB55B	10970	112	7.000		GB112A	11084
56	3.500		GB56B	10972	113	7.063		GB113A	11086
57	3.563		GB57B	10974	114	7.125		GB114A	11088
58	3.625		GB58B	10976	115	7.188		GB115A	11090
59	3.688		GB59B	10978	116	7.250		GB116A	11092
60	3.750		GB60B	10980	117	7.313		GB117A	11094
61	3.813		GB61B	10982	118	7.375		GB118A	11096
62	3.875		GB62B	10984	119	7.438		GB119A	11098
63	3.938		GB63B	10986	120	7.500		GB120A	11100
64	4.000	1.81	GB64B	10988	121	7.563		GB121A	11102
65	4.063		GB65B	10990	122	7.625		GB122A	11104
66	4.125		GB66B	10992	123	7.688		GB123A	11106
67	4.188		GB67B	10994	124	7.750		GB124A	11108
68	4.250		GB68B	10996	125	7.813		GB125A	11110
69	4.313		GB69B	10998	126	7.875		GB126A	11112
70	4.375		GB70B	11000	127	7.938		GB127A	11114
71	4.438		GB71B	11002	128	8.000		GB128A	11116
72	4.500		GB72B	11004					
73	4.563		GB73B	11006					
74	4.625		GB74B	11008					
75	4.688		GB75B	11010					

Style See Page 323	20 - 79 Teeth - A
	80 - 128 Teeth - C

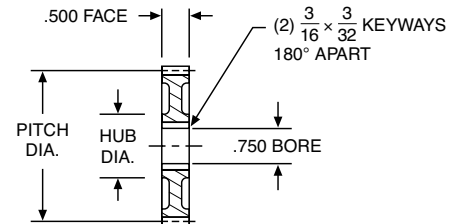

REFERENCE PAGES

- Alterations — 322
- Horsepower Ratings — 52
- Lubrication — 322
- Materials — 323
- Selection Procedure — 49

COMPOUND STEEL BUSHINGS

These steel bushings have 2 keys, 180° apart and fit bores of GB series change gears with a slip fit. They are used to mount two gears on one shaft (or stud) and drive one from the other.

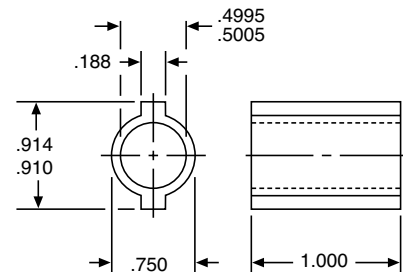

ORDER BY CATALOG NUMBER OR ITEM CODE

CATALOG NO.	ITEM CODE
GBB16A	18502

Change Gears

12 Diametral Pitch (Steel & Cast Iron)

14-1/2° Pressure Angle (will not operate with 20° spurs)

A

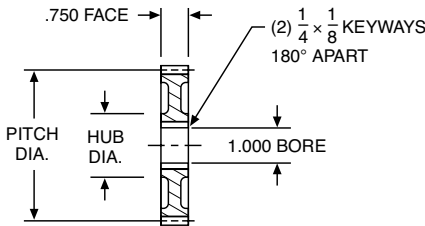

REFERENCE PAGES

- Alterations — 322
- Horsepower Ratings — 53
- Lubrication — 322
- Materials — 323
- Selection Procedure — 49

Compound Steel Bushings

These steel bushings have 2 keys, 180° apart and fit bores of GD series change gears with a slip fit. They are used to mount two gears on one shaft (or stud) and drive one from the other.

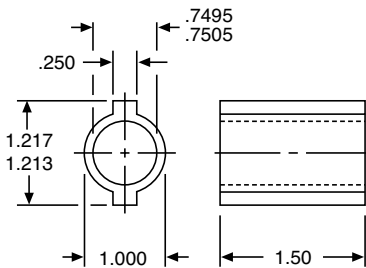

ORDER BY CATALOG NUMBER OR ITEM CODE

CATALOG NO.	ITEM CODE
GDB12A	18504

ALL DIMENSIONS IN INCHES
ORDER BY CATALOG NUMBER OR ITEM CODE

No. of Teeth	Pitch Dia.	Hub Dia.	Catalog Number	Item Code	No. of Teeth	Pitch Dia.	Hub Dia.	Catalog Number	Item Code					
12 DIAMETRAL PITCH														
STEEL					CAST IRON									
Outside Dia. = Pitch Dia. + .167"														
20	1.667	-	GD20	10142	75	6.250	2.19	GD75A	11194					
21	1.750		GD21	10144	76	6.333		GD76A	11196					
22	1.833		GD22	10146	77	6.417		GD77A	11198					
23	1.917		GD23	10148	78	6.500		GD78A	11200					
24	2.000		GD24	10150	79	6.583		GD79A	11202					
25	2.083		GD25	10152	80	6.667		GD80A	11204					
26	2.167		GD26	10154	81	6.750		GD81A	11206					
27	2.250		GD27	10156	82	6.833		GD82A	11208					
28	2.333		GD28	10158	83	6.917		GD83A	11210					
29	2.417		GD29	10160	84	7.000		GD84A	11212					
30	2.500		GD30	10162	85	7.083		GD85A	11214					
31	2.583		GD31	10164	86	7.167		GD86A	11216					
32	2.667		GD32	10166	87	7.250		GD87A	11218					
33	2.750		GD33	10168	88	7.333		GD88A	11220					
34	2.833		GD34	10170	89	7.417		GD89A	11222					
35	2.917		GD35	10172	90	7.500		GD90A	11224					
36	3.000		GD36	10174	91	7.583		GD91A	11226					
CAST IRON					92	7.667		GD92A	11228					
37	3.083		1.76	GD37B	11118	93		7.750	GD93A	11230				
38	3.167			GD38B	11120	94		7.833	GD94A	11232				
39	3.250			GD39B	11122	95		7.917	GD95A	11234				
40	3.333			GD40B	11124	96		8.000	GD96A	11236				
41	3.417			GD41B	11126	97		8.083	GD97A	11238				
42	3.500			GD42B	11128	98		8.167	GD98A	11240				
43	3.583			GD43B	11130	99		8.250	GD99A	11242				
44	3.667			GD44B	11132	100		8.333	GD100A	11244				
45	3.750			GD45B	11134	101		8.417	GD101A	11246				
46	3.833			GD46B	11136	102		8.500	GD102A	11248				
47	3.917			GD47B	11138	103		8.583	GD103A	11250				
48	4.000			GD48B	11140	104		8.667	GD104A	11252				
49	4.083			GD49B	11142	105		8.750	GD105A	11254				
50	4.167			GD50B	11144	106		8.833	GD106A	11256				
51	4.250			GD51B	11146	107		8.917	GD107A	11258				
52	4.333			GD52B	11148	108		9.000	GD108A	11260				
53	4.417			GD53B	11150	109		9.083	GD109A	11262				
54	4.500			GD54B	11152	110		9.167	GD110A	11264				
55	4.583	GD55B		11154	111	9.250	GD111A	11266						
56	4.667	GD56B		11156	112	9.333	GD112A	11268						
57	4.750	GD57B		11158	113	9.417	GD113A	11270						
58	4.833	GD58B		11160	114	9.500	GD114A	11272						
59	4.917	GD59B		11162	115	9.583	GD115A	11274						
60	5.000	GD60B		11164	116	9.667	GD116A	11276						
61	5.083	GD61B		11166	117	9.750	GD117A	11278						
62	5.167	GD62B		11168	118	9.833	GD118A	11280						
63	5.250	GD63A		11170	119	9.917	GD119A	11282						
64	5.333	GD64A		11172	120	10.000	GD120A	11284						
65	5.417	GD65A		11174	<table border="1" style="width: 100%;"> <tr> <td>Style See Page 323</td> <td>20 – 60 Teeth – A</td> </tr> <tr> <td></td> <td>61 – 120 Teeth – C</td> </tr> </table>						Style See Page 323	20 – 60 Teeth – A		61 – 120 Teeth – C
Style See Page 323	20 – 60 Teeth – A													
	61 – 120 Teeth – C													
66	5.500	GD66A		11176										
67	5.583	GD67A		11178										
68	5.667	GD68A		11180										
69	5.750	GD69A		11182										
70	5.833	GD70A		11184										
71	5.917	GD71A	11186											
72	6.000	GD72A	11188											
73	6.083	GD73A	11190											
74	6.167	GD74A	11192											

10 Diametral Pitch (Steel & Cast Iron)

14-1/2° Pressure Angle (will not operate with 20° spurs)

ALL DIMENSIONS IN INCHES
ORDER BY CATALOG NUMBER OR ITEM CODE

No. of Teeth	Pitch Dia.	Hub Dia.	Catalog Number	Item Code	No. of Teeth	Pitch Dia.	Hub Dia.	Catalog Number	Item Code
10 DIAMETRAL PITCH									
STEEL					CAST IRON				
Outside Dia. = Pitch Dia. + .200"									
20	2.000		GF20	10176	61	6.100		GF61A	11346
21	2.100		GF21	10178	62	6.200		GF62A	11348
22	2.200		GF22	10180	63	6.300		GF63A	11350
23	2.300		GF23	10182	64	6.400		GF64A	11352
24	2.400		GF24	10184	65	6.500		GF65A	11354
25	2.500	-	GF25	10186	66	6.600		GF66A	11356
26	2.600		GF26	10188	67	6.700		GF67A	11358
27	2.700		GF27	10190	68	6.800		GF68A	11360
28	2.800		GF28	10192	69	6.900		GF69A	11362
29	2.900		GF29	10194	70	7.000		GF70A	11364
30	3.000		GF30	10196	71	7.100		GF71A	11366
CAST IRON					72	7.200		GF72A	11368
31	3.100		GF31B	11286	73	7.300		GF73A	11370
32	3.200		GF32B	11288	74	7.400		GF74A	11372
33	3.300		GF33B	11290	75	7.500		GF75A	11374
34	3.400		GF34B	11292	76	7.600		GF76A	11376
35	3.500		GF35B	11294	77	7.700		GF77A	11378
36	3.600	1.94	GF36B	11296	78	7.800		GF78A	11380
37	3.700		GF37B	11298	79	7.900		GF79A	11382
38	3.800		GF38B	11300	80	8.000		GF80A	11384
39	3.900		GF39B	11302	81	8.100	3.12	GF81A	11386
40	4.000		GF40B	11304	82	8.200		GF82A	11388
41	4.100		GF41B	11306	83	8.300		GF83A	11390
42	4.200		GF42B	11308	84	8.400		GF84A	11392
43	4.300		GF43B	11310	85	8.500		GF85A	11394
44	4.400		GF44B	11312	86	8.600		GF86A	11396
45	4.500		GF45B	11314	87	8.700		GF87A	11398
46	4.600		GF46B	11316	88	8.800		GF88A	11400
47	4.700		GF47B	11318	89	8.900		GF89A	11402
48	4.800	2.68	GF48B	11320	90	9.000		GF90A	11404
49	4.900		GF49B	11322	91	9.100		GF91A	11406
50	5.000		GF50B	11324	92	9.200		GF92A	11408
51	5.100		GF51B	11326	93	9.300		GF93A	11410
52	5.200		GF52A	11328	94	9.400		GF94A	11412
53	5.300		GF53A	11330	95	9.500		GF95A	11414
54	5.400		GF54A	11332	96	9.600		GF96A	11416
55	5.500		GF55A	11334	97	9.700		GF97A	11418
56	5.600		GF56A	11336	98	9.800		GF98A	11420
57	5.700	3.12	GF57A	11338	99	9.900		GF99A	11422
58	5.800		GF58A	11340	100	10.000		GF100A	11424
59	5.900		GF59A	11342					
60	6.000		GF60A	11344					

Style	20 - 60 Teeth - A
See	61 - 66 Teeth - B
Page	67 - 100 Teeth - C
323	

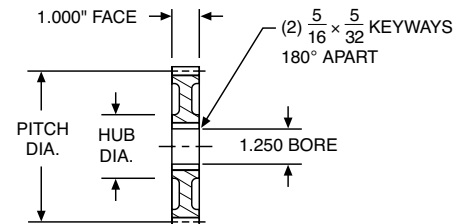

REFERENCE PAGES

- Alterations — 322
- Horsepower Ratings — 54
- Lubrication — 322
- Materials — 323
- Selection Procedure — 49

Compound Steel Bushings

These steel bushings have 2 keys, 180° apart and fit bores of GF series change gears with a slip fit. They are used to mount two gears on one shaft (or stud) and drive one from the other.

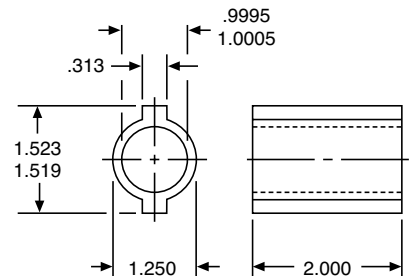

ORDER BY CATALOG NUMBER
OR ITEM CODE

CATALOG NO.	ITEM CODE
GFB10A	18506

Change Gears

8 Diametral Pitch (Steel & Cast Iron)

14-1/2° Pressure Angle (will not operate with 20° spurs)



A

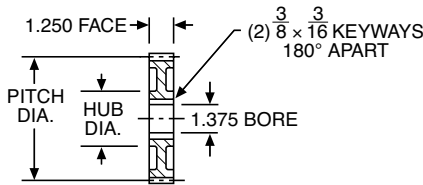

REFERENCE PAGES

- Alterations — 322
- Horsepower Ratings — 55
- Lubrication — 322
- Materials — 323
- Selection Procedure — 49

Compound Steel Bushings

These steel bushings have 2 keys, 180° apart and fit bores of GH series change gears with a slip fit. They are used to mount two gears on one shaft (or stud) and drive one from the other.

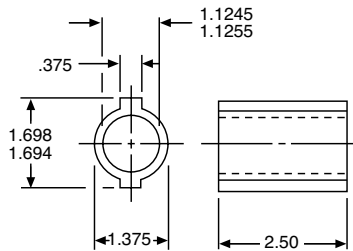

ORDER BY CATALOG NUMBER
OR ITEM CODE

CATALOG NO.	ITEM CODE
GHB8A	18508

ALL DIMENSIONS IN INCHES
ORDER BY CATALOG NUMBER OR ITEM CODE

No. of Teeth	Pitch Dia.	Hub Dia.	Catalog Number	Item Code	No. of Teeth	Pitch Dia.	Hub Dia.	Catalog Number	Item Code
8 DIAMETRAL PITCH									
STEEL					CAST IRON				
Outside Dia. = Pitch Dia. + .250"									
20	2.500	—	GH20	10198	61	7.625		GH61A	11498
21	2.625	—	GH21	10200	62	7.750		GH62A	11500
22	2.750	—	GH22	10202	63	7.875		GH63A	11502
23	2.875	—	GH23	10204	64	8.000		GH64A	11504
24	3.000	—	GH24	10206	65	8.125		GH65A	11506
CAST IRON									
25	3.125	2.06	GH25B	11426	66	8.250	3.25	GH66A	11508
26	3.250		GH26B	11428	67	8.375		GH67A	11510
27	3.375		GH27B	11430	68	8.500		GH68A	11512
28	3.500		GH28B	11432	69	8.625		GH69A	11514
29	3.625		GH29B	11434	70	8.750		GH70A	11516
30	3.750		GH30B	11436	71	8.875		GH71A	11518
31	3.875		GH31B	11438	72	9.000		GH72A	11520
32	4.000		GH32B	11440	73	9.125		GH73A	11522
33	4.125		GH33B	11442	74	9.250		GH74A	11524
34	4.250		GH34B	11444	75	9.375		GH75A	11526
35	4.375	GH35B	11446	76	9.500	GH76A	11528		
36	4.500	GH36B	11448	77	9.625	GH77A	11530		
37	4.625	GH37B	11450	78	9.750	GH78A	11532		
38	4.750	GH38B	11452	79	9.875	GH79A	11534		
39	4.875	GH39B	11454	80	10.000	GH80A	11536		
40	5.000	2.69	GH40B	11456	81	10.125	3.75	GH81A	11538
41	5.125		GH41A	11458	82	10.250		GH82A	11540
42	5.250		GH42A	11460	83	10.375		GH83A	11542
43	5.375		GH43A	11462	84	10.500		GH84A	11544
44	5.500		GH44A	11464	85	10.625		GH85A	11546
45	5.625		GH45A	11466	86	10.750		GH86A	11548
46	5.750		GH46A	11468	87	10.875		GH87A	11550
47	5.875		GH47A	11470	88	11.000		GH88A	11552
48	6.000		GH48A	11472	89	11.125		GH89A	11554
49	6.125		GH49A	11474	90	11.250		GH90A	11556
50	6.250	3.12	GH50A	11476	91	11.375	3.75	GH91A	11558
51	6.375		GH51A	11478	92	11.500		GH92A	11560
52	6.500		GH52A	11480	93	11.625		GH93A	11562
53	6.625		GH53A	11482	94	11.750		GH94A	11564
54	6.750		GH54A	11484	95	11.875		GH95A	11566
55	6.875		GH55A	11486	96	12.000		GH96A	11568
56	7.000		GH56A	11488	97	12.125		GH97A	11570
57	7.125		GH57A	11490	98	12.250		GH98A	11572
58	7.250		GH58A	11492	99	12.375		GH99A	11574
59	7.375		GH59A	11494	100	12.500		GH100A	11576
60	7.500	GH60A	11496						

Style	20 - 49 Teeth - A
See	50 - 57 Teeth - B
Page	58 - 68 Teeth - C
323	69 - 100 Teeth - D

Stem Pinions

20 through 6 Diametral Pitch (Steel)

14-1/2° Pressure Angle (will not operate with 20° spurs)

Boston Gear Stem Pinions feature small numbers of teeth cut integral on a steel shaft. Undercutting of the teeth is minimized by the use of special enlarged Pitch Diameters. When run with standard stock spur gears, they provide high ratios not normally found in spur gear drives. They are not intended to be operated with each other, with internal gears or with 11 tooth pinions, but will run satisfactorily with all other standard 14½° Pressure Angle spur gears.

ALL DIMENSIONS IN INCHES
ORDER BY CATALOG NUMBER OR ITEM CODE

No. of Teeth	Pitch Dia.*	Stem Dia.	Stem Length	Overall Length	Catalog Number	Item Code
20 DIAMETRAL PITCH FACE = 1.125"						
5	.287	.375	2.875	4.500	NAR5	09654
6	.335	.375	2.875	4.500	NAR6	09656
8	.430	.500	3.375	5.000	NAR8	09658
10	.525	.625	3.375	5.000	NAR10	09660
16 DIAMETRAL PITCH FACE = 1.375"						
5	.359	.4375	3.125	5.000	NBR5	09696
6	.419	.500	3.125	5.000	NBR6	09698
8	.537	.625	3.375	5.250	NBR8	09700
10	.656	.750	3.375	5.250	NBR10	09702
12 DIAMETRAL PITCH FACE = 2.000"						
5	.479	.625	4.375	7.250	NDR5	09734
6	.558	.625	4.375	7.250	NDR6	09736
7	.637	.750	4.375	7.250	NDR7	09738
8	.716	.875	4.375	7.250	NDR8	09740
10	.875	1.000	4.375	7.250	NDR10	09742
10 DIAMETRAL PITCH FACE = 2.250"						
5	.575	.750	4.375	7.500	NFR5	09768
6	.670	.750	4.375	7.500	NFR6	09770
7	.765	.875	4.375	7.500	NFR7	09772
8	.860	1.000	4.375	7.500	NFR8	09774
10	1.050	1.125	4.375	7.500	NFR10	09776
8 DIAMETRAL PITCH FACE = 2.500"						
5	.718	.875	4.375	7.750	NHR5	09796
6	.837	1.000	4.375	7.750	NHR6	09798
7	.956	1.125	4.375	7.750	NHR7	09800
8	1.075	1.125	4.375	7.750	NHR8	09802
10	1.312	1.500	4.375	7.750	NHR10	09804
6 DIAMETRAL PITCH FACE = 3.000"						
5	.958	1.250	4.375	8.500	NJR5	09822
6	1.116	1.375	4.375	8.500	NJR6	09824
8	1.433	1.625	5.000	9.000	NJR8	09826
10	1.750	2.000	5.375	9.500	NJR10	09828

*Used for calculating Center Distance, not ratio.

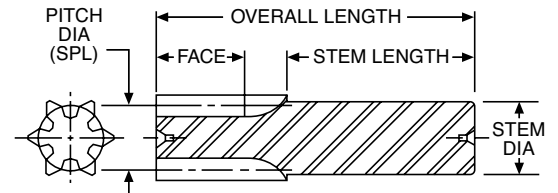
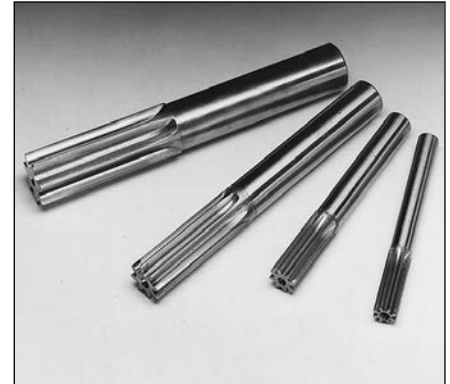

STANDARD TOLERANCES

DIMENSION	TOLERANCE
STEM DIA.	All +.0000 - .0015

Drawn Pinion Wire

48, 32 and 24 Diametral Pitch (Brass & Steel)

14-1/2° Pressure Angle (will not operate with 20° spurs)

A

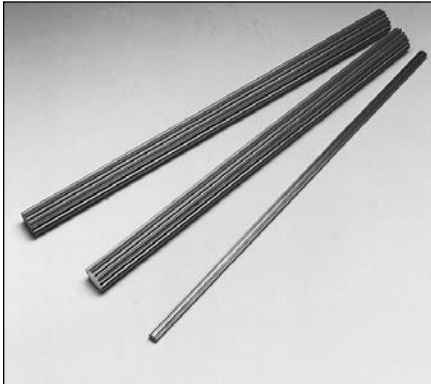

Drawn Pinion Wire, teeth not generated. All Pinion Wire is stocked in 4 foot pieces. Other lengths can be furnished on special order. Price on application.

ALL DIMENSIONS IN INCHES
ORDER BY CATALOG NUMBER OR ITEM CODE

No. of Teeth	Pitch Dia.	Catalog Number	Item Code
48			
DIAMETRAL PITCH			
BRASS			
6	.125	G24	36900
8	.167	G25	36902
9	.188	G26	36904
10	.208	G27	36906
12	.250	G29	36908
14	.292	G30	36910
15	.312	G31	36912
16	.333	G32	36914
18	.375	G33	36916
STEEL			
6	.125	GS24	36954
8	.167	GS25	36956
9	.188	GS26	36958
10	.208	GS27	36960
12	.250	GS29	36962
14	.292	GS30	36964
15	.312	GS31	36966
16	.333	GS32	36968
18	.375	GS33	36970
32			
DIAMETRAL PITCH			
BRASS			
6	.188	G39	36918
8	.250	G40	36920
9	.281	G41	36922
10	.312	G42	36924
11	.344	G43	36926
12	.375	G44	36928
14	.438	G45	36930
15	.469	G46	36932
16	.500	G47	36934
STEEL			
6	.188	GS39	36972
8	.250	GS40	36974
9	.281	GS41	36976
10	.312	GS42	36978
11	.344	GS43	36980
12	.375	GS44	36982
14	.438	GS45	36984
15	.469	GS46	36986
16	.500	GS47	36988
24			
DIAMETRAL PITCH			
BRASS			
6	.250	G54	36936
9	.375	G56	36940
10	.417	G57	36942
12	.500	G59	36946
14	.583	G60	36948
15	.625	G61	36950
16	.667	G62	36952
STEEL			
6	.250	GS54	36990
8	.333	GS55	36992
9	.375	GS56	36994
10	.417	GS57	36996
11	.458	GS58	36998
12	.500	GS59	37000
14	.583	GS60	37002
15	.625	GS61	37004
16	.667	GS62	37006

48 through 3 Diametral Pitch (Nylon & Steel) 14-1/2° Pressure Angle (will not operate with 20° spurs)

ALL DIMENSIONS IN INCHES
ORDER BY CATALOG NUMBER OR ITEM CODE

Overall Thickness	Pitch Line to Back (B)	Nominal Length (Feet)	Mating Spur Gear Page #	Nylon		Steel	
				Catalog Number	Item Code	Catalog Number	Item Code
48 DIAMETRAL PITCH				FACE WIDTH = .125"			
.125	.104	1/2	18	GP586-1	53899	-	-
				-	-	L501-2	12726
32 DIAMETRAL PITCH				FACE WIDTH = .188"			
.188	.156	1/2	18, 19	GP583-1	53900	-	-
		2/4		-	-	L503-2	12728
				-	-	L503-4	12730
24 DIAMETRAL PITCH				FACE WIDTH = .250"			
.250	.208	1/2	19, 20	GP579-1	53901	-	-
		2/4		-	-	L505-2	12732
				-	-	L505-4	12734
20 DIAMETRAL PITCH				FACE WIDTH = .375"			
.375	.325	2/4	20, 21	-	-	L509-2	12736
		4/6		-	-	L509-4	12738
				-	-	L509-6	12740
16 DIAMETRAL PITCH				*FACE WIDTH = .313"			
.313	.250	2/4	21, 22	-	-	L510-2	12742
				-	-	L510-4	12744
16 DIAMETRAL PITCH				*FACE WIDTH = .500"			
.500	.438	4/6	21, 22	-	-	L512-4	12746
				-	-	L512-6	12748
12 DIAMETRAL PITCH				FACE WIDTH = .750"			
.500	.417	4/6	22, 23	-	-	L514-4	12750
				-	-	L514-6	12752
.750	.667	4/6		-	-	L515-4	12754
				-	-	L515-6	12756
10 DIAMETRAL PITCH				FACE WIDTH = 1.000"			
.625	.525	4/6	23, 24	-	-	L516-4	37324
				-	-	L516-6	37326
1.000	.900	4/6		-	-	L517-4	37328
				-	-	L517-6	37330
8 DIAMETRAL PITCH				FACE WIDTH = 1.250"			
.750	.625	4/6	24, 25	-	-	L518-4	37332
				-	-	L518-6	37334
1.250	1.125	4/6		-	-	L519-4	37336
				-	-	L519-6	37338
6 DIAMETRAL PITCH				FACE WIDTH = 1.500"			
1.000	.833	4/6	25, 26	-	-	L520-4	37340
				-	-	L520-6	37342
1.500	1.333	4/6		-	-	L521-4	37344
				-	-	L521-6	37346
5 DIAMETRAL PITCH				FACE WIDTH = 1.750"			
1.250	1.050	4/6	26	-	-	L522-4	37348
				-	-	L522-6	37350
4 DIAMETRAL PITCH				FACE WIDTH = 2.000"			
1.500	1.250	4/6	27	-	-	L523-4	37352
				-	-	L523-6	37354
3 DIAMETRAL PITCH				FACE WIDTH = 3.000"			
1.500	1.167	4/6	27	-	-	L524-4	37356
				-	-	L524-6	37358

*Face Width of L512-4 and L512-6 = 1/2".

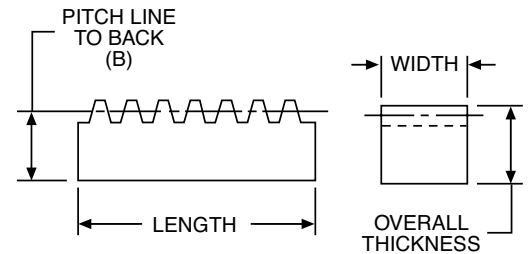
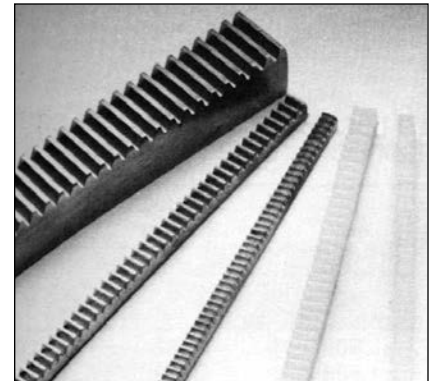

STANDARD TOLERANCES†

DIMENSION	TOLERANCE
LENGTH†	All + 1.00 - .000
FACE WIDTH	1/8 - 3/4 + .000 - .002
	1 - 1-1/2 + .000 - .003
	1-3/4 - 2 + .000 - .004
	3 + .000 - .006

†Ends not machined. Tolerance allows for cutting and matching. Nylon Rack is molded in proper lengths to permit end to end butting without interruption of tooth spacing.

‡Steel only.

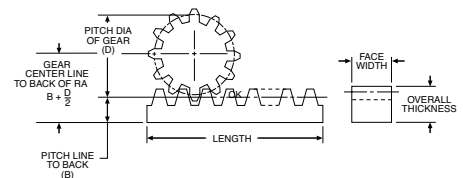

REFERENCE PAGES

Alterations — 322
Lubrication — 322
Materials — 323

Internal Gears

48 through 16 Diametral Pitch (Brass)

14-1/2° Pressure Angle (will not operate with 20° spurs)

A

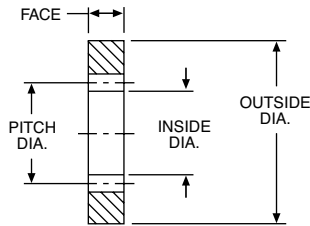
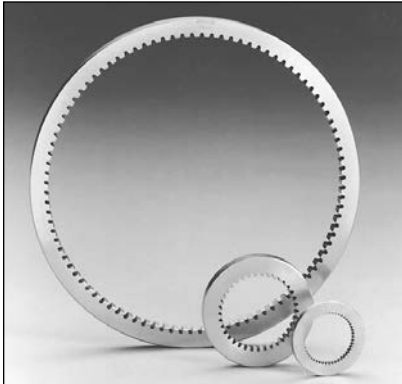

STANDARD TOLERANCES

DIMENSION		TOLERANCE	
I.D.	48 Pitch	All	+.004 - .000
	32 Pitch	All	+.005 - .000
	24 Pitch	All	+.006 - .000
	16 Pitch	All	+.008 - .000
O.D.	All		+.001 + .003

ALL DIMENSIONS IN INCHES
ORDER BY CATALOG NUMBER OR ITEM CODE

No. of Teeth	Pitch Dia.	O.D.	I.D.	Catalog Number	Item Code
48					
DIAMETRAL PITCH					
FACE = .125"					
48	1.000	1.500	.986	G632	12066
72	1.500	2.000	1.486	G633	12068
96	2.000	2.750	1.986	G635	12070
144	3.000	3.750	2.986	G637	12072
32					
DIAMETRAL PITCH					
FACE = .188"					
48	1.500	2.000	1.480	G664	12056
64	2.000	2.750	1.980	G666	12058
96	3.000	3.750	2.980	G668	12060
128	4.000	4.750	3.980	G669	12062
192	6.000	6.750	5.980	G670	12064
24					
DIAMETRAL PITCH					
FACE = .250"					
36	1.500	2.250	1.474	G675	12046
48	2.000	2.750	1.974	G677	12048
72	3.000	3.750	2.974	G679	12050
96	4.000	4.750	3.974	G680	12052
144	6.000	6.750	5.974	G681	12054
16					
DIAMETRAL PITCH					
FACE = .313"					
32	2.000	2.750	1.962	G689	12038
48	3.000	3.750	2.962	G691	12040
64	4.000	4.750	3.962	G692	12042
96	6.000	6.750	5.962	G693	12044

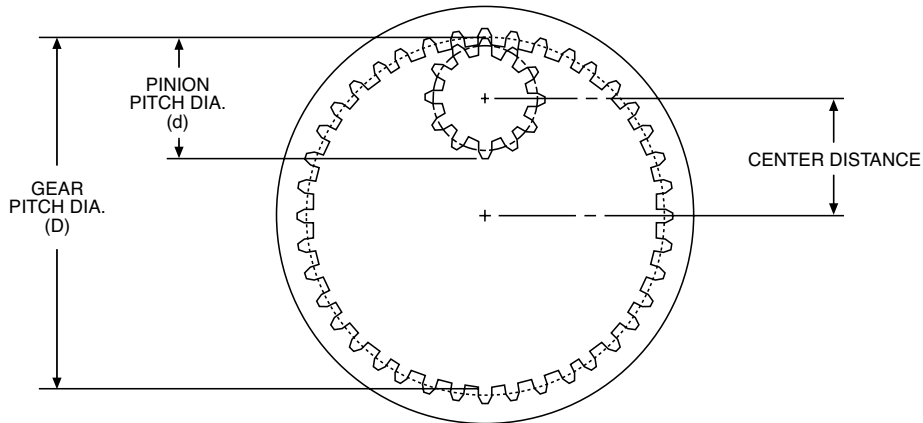

$$\text{CENTER DISTANCE} = \frac{D-d}{2}$$

NOTE: The difference in tooth numbers between Gear and Pinion should not be less than 15.

64 and 48 Diametral Pitch (Delrin & Brass)

20° Pressure Angle (will not operate with 14-1/2° spurs)

ALL DIMENSIONS IN INCHES
ORDER BY CATALOG NUMBER OR ITEM CODE

No. of Teeth	Pitch Dia.	Bore	Hub		Style See Page 323	Without Keyway or Setscrew	
			Dia.	Proj.		Catalog Number	Item Code
64 DIAMETRAL PITCH						Face = .125" Outside Dia. = Pitch Dia. + .033" Overall Length = .125" + Hub Proj.	
BRASS							
16	.250	.125	.19	.19	A	Y6416	09482
18	.281		.22			Y6418	09484
20	.312		.25			Y6420	09486
24	.375		.28			Y6424	09488
28	.438		.34			Y6428	09490
32	.500	.1875	.38	.25		Y6432	09492
36	.562		.44			Y6436	09494
40	.625		.44			Y6440	09496
44	.688		.50			Y6444	09498
48	.750		.50			Y6448	09500
52	.812		.56		Y6452	09502	
56	.875		.56		Y6456	09504	
60	.938	.62	Y6460	09506			
64	1.000	.250	.62	.25	Y6464	09508	
72	1.125		.69		Y6472	09510	
80	1.250		.69		Y6480	09512	
88	1.375		.75		Y6488	09514	
96	1.500		.75		Y6496	09516	
112	1.750		.81		Y64112	09518	
128	2.000		.88		Y64128	09520	
144	2.250		.3125		.75	.31	C
160	2.500	.75		Y64160	09524		
192	3.000	.88		Y64192	09526		
48 DIAMETRAL PITCH							Face = .125" Outside Dia. = Pitch Dia. + .042" Overall Length = .125" + Hub Proj.
MOLDED DELRIN							
18	.375	.1562	.31	.25	A	YP4818	53902
19	.396		.34			YP4819	53903
20	.417		.34			YP4820	53904
21	.438		.34			YP4821	53905
22	.458		.38			YP4822	53906
23	.479		.38			YP4823	53907
24	.500		.41			YP4824	53908
25	.521		.41			YP4825	53909
26	.542		.45			YP4826	53910
27	.562		.45			YP4827	53911
28	.583	.48	YP4828	53912			
29	.604	.48	YP4829	53913			
30	.625	.50	YP4830	53914			
31	.646	.1875	.55	.25	YP4831	53915	
32	.667				YP4832	53916	
33	.688				YP4833	53917	
34	.708				YP4834	53918	
35	.729				YP4835	53919	
36	.750				YP4836	53920	
37	.771				YP4837	53921	
38	.792				YP4838	53922	
39	.813				YP4839	53923	
40	.833				YP4840	53924	
42	.875				YP4842	53925	

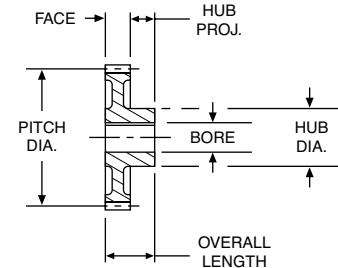
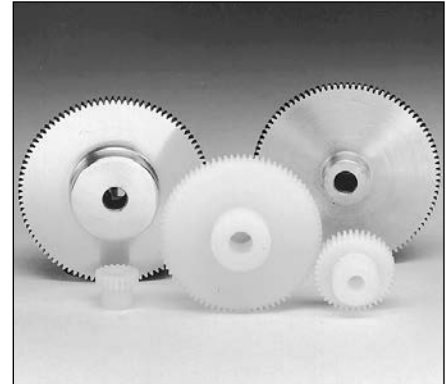

STANDARD TOLERANCES

DIMENSION		TOLERANCE
BORE	All	±.0005



48 D.P.



64 D.P.

REFERENCE PAGES

Alterations — 322
Lubrication — 322
Materials — 323

Spur Gears

48 Diametral Pitch (Delrin)

20° Pressure Angle (will not operate with 14-1/2° spurs)

A

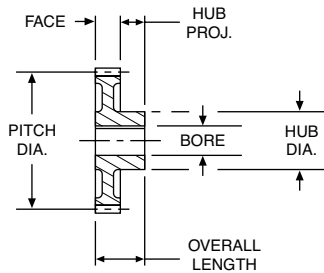
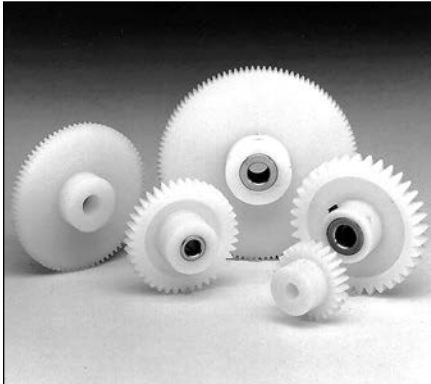

STANDARD TOLERANCES*

DIMENSION		TOLERANCE
BORE	All	+ .001 - .000

*Gears with Brass Inserts only.



REFERENCE PAGES

Alterations — 322
Materials — 323

†All YPB gears have setscrews.

BORE	SETScrew
1/8	#2-56
3/16	#4-40
1/4	#6-32

ALL DIMENSIONS IN INCHES
ORDER BY CATALOG NUMBER OR ITEM CODE

No. of Teeth	Pitch Dia.	Bore	Hub		Style See Page 323	Without Keyway or Setscrew†				
			Dia.	Proj.		Catalog Number	Item Code			
48 DIAMETRAL PITCH						Face = .125" Outside Dia. = Pitch Dia. + .042" Overall Length = .125" + Hub Proj.				
MOLDED DELRIN										
44	.917	.188	.55	.25	B	YP4844	53926			
45	.938					YP4845	53927			
48	1.000					YP4848	53928			
52	1.083					YP4852	53929			
54	1.125					YP4854	53930			
56	1.168					YP4856	53931			
60	1.250					YP4860	53932			
64	1.333					YP4864	53933			
66	1.375					YP4866	53934			
72	1.500					YP4872	53935			
80	1.667	YP4880	53936							
84	1.750	YP4884	53937							
96	2.000	YP4896	53938							
100	2.083	YP48100	53939							
108	2.250	YP48108	53940							
120	2.500	YP48120	53941							
MOLDED DELRIN WITH BRASS INSERTS										
18	.375	.125	.31	.25	A	YPB4818	53942			
19	.396					YPB4819	53943			
20	.417					YPB4820	53944			
21	.438					YPB4821	53945			
22	.458					YPB4822	53946			
23	.479					YPB4823	53947			
24	.500					YPB4824	53948			
25	.521	YPB4825	53949							
26	.542	.188	.45	.25	A	YPB4826	53950			
27	.562					YPB4827	53951			
28	.583					YPB4828	53952			
29	.604					YPB4829	53953			
30	.625					YPB4830	53954			
31	.646		YPB4831			53955				
32	.667		YPB4832			53956				
33	.688		YPB4833			53957				
34	.708		YPB4834			53958				
35	.729		YPB4835			53959				
36	.750	YPB4836	53960							
37	.771	.55	.25	B	YPB4837	53961				
38	.792				YPB4838	53962				
39	.813				YPB4839	53963				
40	.833				YPB4840	53964				
42	.875				YPB4842	53965				
44	.917				YPB4844	53966				
45	.938				YPB4845	53967				
48	1.000				.250	.61	.25	B	YPB4848	53968
52	1.083								YPB4852	53969
54	1.125								YPB4854	53970
56	1.168	YPB4856	53971							
60	1.250	YPB4860	53972							
64	1.333	YPB4864	53973							
66	1.375	YPB4866	53974							
72	1.500	YPB4872	53975							
80	1.667	YPB4880	53976							
84	1.750	YPB4884	53977							
96	2.000	YPB4896	53978							
100	2.083	YPB48100	53979							
108	2.250	YPB48108	53980							
120	2.500	YPB48120	53981							

48 and 32 Diametral Pitch (Delrin & Brass)

20° Pressure Angle (will not operate with 14-1/2° spurs)

ALL DIMENSIONS IN INCHES
ORDER BY CATALOG NUMBER OR ITEM CODE

No. of Teeth	Pitch Dia.	Bore	Hub		Style See Page 323	Without Keyway or Setscrew			
			Dia.	Proj.		Catalog Number	Item Code		
48 DIAMETRAL PITCH						Face = .125" Outside Dia. = Pitch Dia. + .042" Overall Length = .125" + Hub Proj.			
BRASS									
12	.250	.125	.18	.19	A	Y4812	09444		
15	.312		.22			Y4815	09446		
18	.375		.28			Y4818	09448		
21	.438		.35			Y4821	09450		
24	.500	.1875	.38	.25	A	Y4824	09452		
27	.562		.44			Y4827	09454		
30	.625		.44			Y4830	09456		
36	.750		.50			Y4836	09458		
42	.875		.57			Y4842	09460		
48	1.000	.250	.63	.25	A	Y4848	09462		
54	1.125		.69			Y4854	09464		
60	1.250		.69			Y4860	09466		
66	1.375		.75			Y4866	09468		
72	1.500		.75			Y4872	09470		
84	1.750		.82			Y4884	09472		
96	2.000		.88			Y4896	09474		
120	2.500		.3125			.75	.31	C	Y48120
144	3.000	.88		Y48144	09478				
192	4.000	1.00		Y48192	09480				
32 DIAMETRAL PITCH						Face = .188" Outside Dia. = Pitch Dia. + .062" Overall Length = .188" + Hub Proj.			
MOLDED DELRIN									
12	.375	.1562	.28	.31	A	YP3212	53982		
14	.438		.31			YP3214	53983		
15	.469		.31			YP3215	53984		
16	.500		.34			YP3216	53985		
18	.562		.34			YP3218	53986		
20	.625	.1875	.47	.31	A	YP3220	53987		
22	.688		.50			YP3222	53988		
24	.750		.50			YP3224	53989		
26	.812		.56			YP3226	53990		
28	.875		.50			YP3228	53991		
30	.938		.56			YP3230	53992		
32	1.000	.250	.63	.31	B	YP3232	53993		
34	1.062		.61			.31	YP3234	53994	
36	1.125						YP3236	53995	
38	1.187						YP3238	53996	
40	1.250						YP3240	53997	
42	1.312						YP3242	53998	
44	1.375						YP3244	53999	
48	1.500						.63	YP3248	54000
52	1.625	.3125	.67	.31	B	YP3252	54001		
56	1.750					YP3256	54002		
64	2.000					YP3264	54003		
72	2.250					YP3272	54004		
80	2.500					.81	.31	YP3280	54005
96	3.000							YP3296	54006

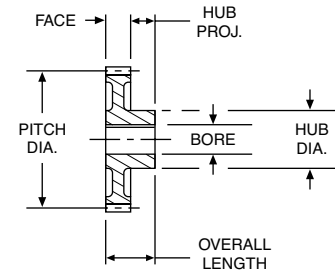
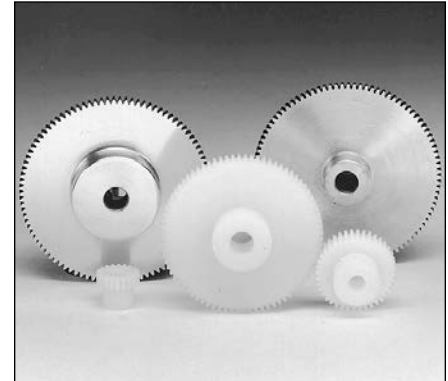

STANDARD TOLERANCES*

DIMENSION	TOLERANCE
BORE	All ±.0005"

*Brass only.



48 D.P.



32 D.P.

REFERENCE PAGES

Alterations — 322
Lubrication — 322
Materials — 323

Spur Gears

32 Diametral Pitch (Delrin & Brass)

20° Pressure Angle (will not operate with 14-1/2° spurs)

A

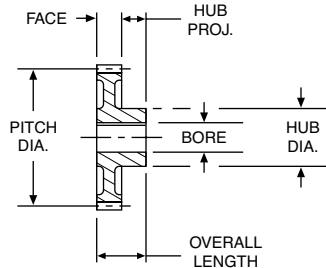
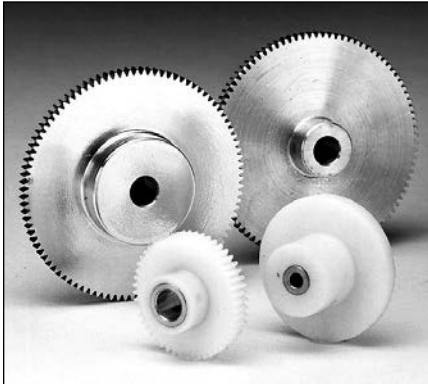

STANDARD TOLERANCES

DIMENSION		TOLERANCE
Brass		
BORE	All	± .0005
Delrin with Brass Inserts		
BORE	All	+ .001 - .000



32 D.P.

REFERENCE PAGES

Alterations — 322
 Lubrication — 322
 Materials — 323

†All YPB gears have setscrew and spot drill.

BORE	SETScrew
1/8	#2-56
3/16	#4-40
1/4	#6-32
5/16	#8-32

ALL DIMENSIONS IN INCHES
 ORDER BY CATALOG NUMBER OR ITEM CODE

No. of Teeth	Pitch Dia.	Bore	Hub		Style See Page 323	Without Keyway or Setscrew†				
			Dia.	Proj.		Catalog Number	Item Code			
32 DIAMETRAL PITCH						Face = .188" Outside Dia. = Pitch Dia. + .062" Overall Length = .188" + Hub Proj.				
MOLDED DELRIN with BRASS INSERTS										
12	.375	.125	.28	.31	A	YPB3212	54007			
14	.438		.31			YPB3214	54008			
15	.469		.31			YPB3215	54009			
16	.500		.34			YPB3216	54010			
18	.562		.34			YPB3218	54011			
20	.625		.1875			.47	YPB3220	54012		
22	.688	.50				YPB3222	54013			
24	.750	.50				YPB3224	54014			
26	.812	.56				YPB3226	54015			
28	.875	.50				YPB3228	54016			
30	.938	.56				YPB3230	54017			
32	1.000	.250	.63			B	YPB3232	54018		
34	1.062		.61				YPB3234	54019		
36	1.125		.61				YPB3236	54020		
38	1.187		.61				YPB3238	54021		
40	1.250		.61				YPB3240	54022		
42	1.312		.61				YPB3242	54023		
44	1.375	.61	YPB3244				54024			
48	1.500	.63	YPB3248	54025						
52	1.625	.3125	.67	C	YPB3252		54026			
56	1.750		.67		YPB3256		54027			
64	2.000		.67		YPB3264		54028			
72	2.250		.81		YPB3272		54029			
80	2.500		.81		YPB3280		54030			
96	3.000		.81		YPB3296		54031			
BRASS										
12	.375	.125	.28		.25		A	Y3212	09406	
14	.438		.34					Y3214	09408	
16	.500		.40					Y3216	09410	
18	.562		.43			Y3218		09412		
20	.625		.47			Y3220		09414		
24	.750		.53			Y3224		09416		
28	.875	.59	Y3228			09418				
32	1.000	.250	.66			.25		Y3232	09420	
36	1.125		.72					Y3236	09422	
40	1.250		.72					Y3240	09424	
48	1.500		.78					Y3248	09426	
56	1.750		.3125	.84				.31	Y3256	09428
64	2.000			.90					Y3264	09430
72	2.250	.88		Y3272					09432	
80	2.500	.88		Y3280					09434	
96	3.000	1.00		Y3296					09436	
112	3.500	1.00		Y32112					09438	
128	4.000	1.00	Y32128	09440						
160	5.000	1.00	Y32160	09442						

24 Diametral Pitch (Delrin)

20° Pressure Angle (will not operate with 14-1/2° spurs)

ALL DIMENSIONS IN INCHES
ORDER BY CATALOG NUMBER OR ITEM CODE

No. of Teeth	Pitch Dia.	Bore	Hub		Style See Page 323	Without Keyway or Setscrew†	
			Dia.	Proj.		Catalog Number	Item Code
24 DIAMETRAL PITCH						Face = .250" Outside Dia. = Pitch Dia. + .083" Overall Length = .250" + Hub Proj.	
MOLDED DELRIN							
12	.500	.188	.38	.31	A	YP2412	54032
14	.583		.44			YP2414	54033
15	.625		.48			YP2415	54034
16	.667		.55			YP2416	54035
17	.709					YP2417	54036
18	.750					YP2418	54037
19	.791					YP2419	54038
20	.833		.250			YP2420	54039
21	.875					YP2421	54040
22	.917					YP2422	54041
23	.959	YP2423		54042			
24	1.000	.63		YP2424	54043		
25	1.041	.61		YP2425	54044		
26	1.083	.31	YP2426	54045			
27	1.125		.63	YP2427	54046		
28	1.167		YP2428	54047			
30	1.250		YP2430	54048			
32	1.333		YP2432	54049			
33	1.375		.61	YP2433	54050		
34	1.416		YP2434	54051			
36	1.500		.63	YP2436	54052		
39	1.625		.313	.67	B	YP2439	54053
40	1.666					YP2440	54054
42	1.750	YP2442				54055	
44	1.833	YP2444				54056	
45	1.875	YP2445				54057	
48	2.000	YP2448				54058	
50	2.083	YP2450				54059	
52	2.166	YP2452				54060	
54	2.250	YP2454				54061	
56	2.333	YP2456				54062	
60	2.500	YP2460	54063				
MOLDED DELRIN WITH BRASS INSERTS							
12	.500	.188	.38	.31	A	YPB2412	54064
14	.583		.44			YPB2414	54065
15	.625		.48			YPB2415	54066
16	.667		.55			YPB2416	54067
17	.709					YPB2417	54068
18	.750					YPB2418	54069
19	.791					YPB2419	54070
20	.833		.250			YPB2420	54071
21	.875					YPB2421	54072
22	.917					YPB2422	54073
23	.959	YPB2423		54074			
24	1.000	.63		YPB2424	54075		
25	1.041	.61		YPB2425	54076		
26	1.083	.31	YPB2426	54077			
27	1.125		.63	YPB2427	54078		
28	1.167		YPB2428	54079			
30	1.250		YPB2430	54080			
32	1.333		YPB2432	54081			
33	1.375		.61	YPB2433	54082		
34	1.416		YPB2434	54083			
36	1.500		.63	YPB2436	54084		
39	1.625		.313	.67	B	YPB2439	54085
40	1.666					YPB2440	54086
42	1.750	YPB2442				54087	

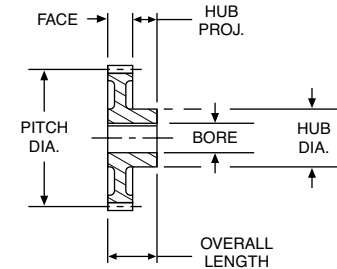
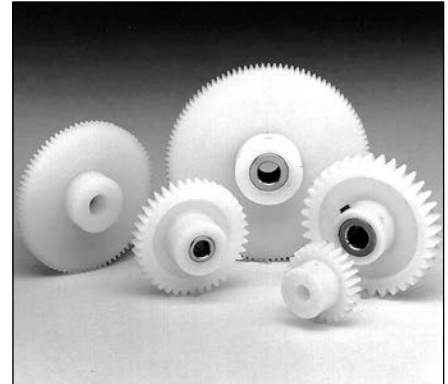

STANDARD TOLERANCES*

DIMENSION	TOLERANCE
BORE	All +.001 - .000

*Gears with Brass Inserts only.



24 D.P.

REFERENCE PAGES

Alterations — 322
Materials — 323

†All YPB gears have setscrew and spot drill.

BORE	SETSCREW
3/16	#4-40
1/4	#6-32
5/16	#8-32

Spur Gears

24 and 20 Diametral Pitch (Delrin, Brass, Steel & Cast Iron)

20° Pressure Angle (will not operate with 14-1/2° spurs)

A

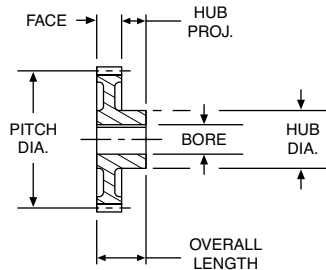
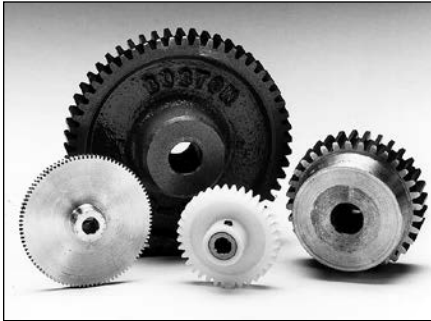

STANDARD TOLERANCES

DIMENSION		TOLERANCE
Brass, Steel and Cast Iron		
BORE	All	± .0005
Delrin with Brass Inserts		
BORE	All	+ .001 - .000



24 D.P.



20 D.P.

REFERENCE PAGES

- Alterations — 322
- Horsepower Ratings — 58
- Lubrication — 322
- Materials — 323
- Selection Procedure — 49

†YPB gears have one setscrew (#8-32), no keyway.

*5/16" bore have #35 (.110) drilled hole through one wall, no keyway.

‡3/8" bore have one setscrew. No keyway.

1/2" bore and larger have standard keyway at 90° to setscrew. See Page 323.

ALL DIMENSIONS IN INCHES
ORDER BY CATALOG NUMBER OR ITEM CODE

No. of Teeth	Pitch Dia.	Bore	Hub		Style See Page 323	Without Keyway or Setscrew		With Keyway and Setscrew†					
			Dia.	Proj.		Catalog Number	Item Code	Catalog Number	Item Code				
24 DIAMETRAL PITCH						Face = .250" Outside Dia. = Pitch Dia. + .083" Overall Length = .250" + Hub Proj.							
MOLDED DELRIN WITH BRASS INSERTS													
44	1.833	.3125	.67	.31	B	YPB2444	54088	-	-				
45	1.875					YPB2445	54089	-	-				
48	2.000					YPB2448	54090	-	-				
50	2.083					YPB2450	54091	-	-				
52	2.166					YPB2452	54092	-	-				
54	2.250					YPB2454	54093	-	-				
56	2.333					YPB2456	54094	-	-				
60	2.500					YPB2460	54095	-	-				
BRASS													
12	.500					.1875	.38	.25	A	Y2412	09372	-	-
15	.625	Y2415	09374	-	-								
18	.750	Y2418	09376	-	-								
21	.875	Y2421	09378	-	-								
24	1.000	Y2424	09380	-	-								
27	1.125	Y2427	09382	-	-								
30	1.250	Y2430	09384	-	-								
36	1.500	Y2436	09386	-	-								
42	1.750	.3125	.86	.25	C					Y2442	09388	-	-
48	2.000									Y2448	09390	-	-
54	2.250					Y2454	09392	-	-				
60	2.500					Y2460	09394	-	-				
72	3.000					Y2472	09396	-	-				
84	3.500					Y2484	09398	-	-				
96	4.000					Y2496	09400	-	-				
120	5.000					Y24120	09402	-	-				
144	6.000					Y24144	09404	-	-				
20 DIAMETRAL PITCH						Face = .500" Outside Dia. = Pitch Dia. + .100" Overall Length = .500" + Hub Proj.							
STEEL													
12	.600	.3125	.46	.44	A	YA12	09892	YA12-5/16*	46128				
14	.700					YA14	09894	YA14-5/16*	46129				
15	.750					YA15	09896	YA15-3/8‡	46130				
16	.800					YA16	09898	YA16-3/8‡	46131				
18	.900					YA18	09900	YA18-3/8‡	46132				
20	1.000					YA20	09902	YA20-1/2	46133				
24	1.200					YA24	09914	YA24-1/2	46134				
25	1.250					YA25	09904	YA25-1/2	46135				
30	1.500					YA30	09906	YA30-1/2	46136				
35	1.750					YA35	09908	YA35-1/2	46137				
40	2.000	.500	1.72	.50	A	YA40	09910	YA40-1/2	46138				
	.625					-	-	YA40-5/8	46139				
	.750					-	-	YA40-3/4	46140				
45	2.250					YA45	09912	-	-				
50	2.500					YA50A	10548	-	-				
60	3.000					YA60A	10550	-	-				
70	3.500					YA70A	10552	-	-				
CAST IRON													
80	4.000					.625	1.38	.62	C	YA80	10554	-	-
84	4.200									YA84	10556	-	-
90	4.500	YA90	10558	-	-								
100	5.000	YA100	10560	-	-								
120	6.000	YA120	10562	-	-								
140	7.000	YA140	10564	-	-								
160	8.000	YA160	10566	-	-								
180	9.000	YA180	10568	-	-								
200	10.000	YA200	10570	-	-								

16 and 12 Diametral Pitch (Steel & Cast Iron) 20° Pressure Angle (will not operate with 14-1/2° spurs)

ALL DIMENSIONS IN INCHES
ORDER BY CATALOG NUMBER OR ITEM CODE

No. of Teeth	Pitch Dia.	Bore	Hub		Style See Page 323	Without Keyway or Setscrew		With Keyway and Setscrew†	
			Dia.	Proj.		Catalog Number	Item Code	Catalog Number	Item Code
16 DIAMETRAL PITCH									
						Face = .750" Outside Dia. = Pitch Dia. + .125" Overall Length = .750" + Hub Proj.			
STEEL									
12	.750	.375	.56	.50	A	YB12	09916	YB12-3/8†	46141
14	.875	.375	.69	.50		YB14	09918	YB14-3/8†	46142
15	.938	.500	.75	.50		YB15	09920	YB15-3/8†	45991
						-	-	YB15-1/2	46143
16	1.000	.500	.81	.50		YB16	09922	YB16-1/2	46144
18	1.125	.500	.94	.50		YB18	09924	YB18-1/2	46145
20	1.250	.625	1.05	.50		YB20	09926	YB20-5/8	46146
24	1.500	.750	1.20	.50		YB24	09928	YB24-5/8	46147
						-	-	YB24-3/4	46148
28	1.750	.750	1.45	.50		YB28	09930	YB28-5/8	46149
						-	-	YB28-3/4	46150
30	1.875	.875	1.58	.50		YB30	09932	YB30-5/8	46151
						-	-	YB30-3/4	46152
						-	-	YB30-7/8	46153
32	2.000	1.000	1.70	.50		YB32	09934	YB32-5/8	46154
						-	-	YB32-3/4	46155
						-	-	YB32-7/8	46156
						-	-	YB32-1	46157
36	2.250	.625	1.95	.50		YB36	09936	-	-
40	2.500	.625	2.20	.50		YB40	09938	-	-
48	3.000	.625	2.00	.62	YB48A	10572	-	-	
56	3.500	.625	2.50	.62	YB56A	10574	-	-	
60	3.750	.625	2.75	.62	YB60A	10576	-	-	
64	4.000	.750	2.88	.75	YB64A	10578	-	-	
72	4.500	.750	3.38	.75	YB72A	10580	-	-	
80	5.000	.750	3.88	.75	YB80A	10582	-	-	
CAST IRON									
96	6.000	.750	1.75	.75	D	YB96	10584	-	-
128	8.000	.750	2.00	.75		YB128	10588	-	-
144	9.000	.750	2.00	.75		YB144	10590	-	-
160	10.000	.875	2.00	.75		YB160	10592	-	-
192	12.000	.875	2.00	1.00		YB192	10594	-	-
						-	-	-	-
						Face = 1.000" Outside Dia. = Pitch Dia. + .167" Overall Length = 1.000" + Hub Proj.			
12 DIAMETRAL PITCH									
STEEL									
12	1.000	.500	.75	.62	A	YD12	09940	YD12-1/2*	46158
13	1.083	.625	.83	.62		YD13	09942	YD13-5/8‡	46159
14	1.167	.625	.92	.62		YD14	09944	YD14-5/8	46160
15	1.250	.625	.99	.62		YD15	09946	YD15-5/8	46161
16	1.333	.625	1.07	.62		YD16	09948	YD16-5/8	46162
18	1.500	.750	1.24	.62		YD18	09950	YD18-3/4	46163
20	1.667	.750	1.32	.62		YD20	09952	YD20-3/4	46164
21	1.750	.875	1.40	.62		YD21	09954	YD21-3/4	46165
						-	-	YD21-7/8	46166
24	2.000	1.000	1.65	.62		YD24	09956	YD24-3/4	46167
						-	-	YD24-7/8	46168
						-	-	YD24-1	46169
28	2.333	1.000	1.99	.62		YD28	09958	YD28-3/4	46170
						-	-	YD28-7/8	46171
						-	-	YD28-1	46172
30	2.500	.750	2.15	.62		YD30	09960	-	-
36	3.000	.750	1.94	.88		YD36A	10596	-	-
42	3.500	.750	2.44	.88		YD42A	10598	-	-
48	4.000	.875	2.88	.88		YD48A	10600	-	-
54	4.500	.875	3.38	.88		YD54A	10602	-	-

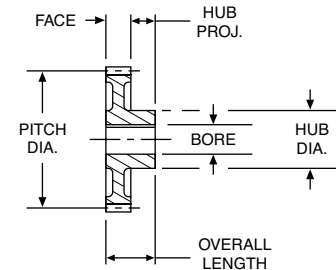

STANDARD TOLERANCES

DIMENSION	TOLERANCE
BORE	All ±.0005



16 D.P.



12 D.P.

REFERENCE PAGES

Alterations — 322
Horsepower Ratings — 58, 59
Lubrication — 322
Materials — 323
Selection Procedure — 49

†3/8" bore have one setscrew.
No keyway.

YB15-1/2 and larger have standard keyway at 90° to setscrew.
See page 323.

*YD12-1/2 has one setscrew.
No keyway.

‡YD13-5/8 has one setscrew.
No keyway.

YD14-5/8 bore and larger have standard keyway at 90° to setscrew.

Spur Gears

12 and 10 Diametral Pitch (Cast Iron & Steel)

20° Pressure Angle (will not operate with 14-1/2° spurs)

A

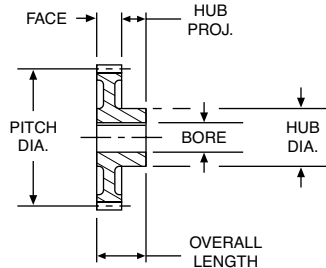

STANDARD TOLERANCES

DIMENSION		TOLERANCE
BORE	All	±.0005



12 D.P.

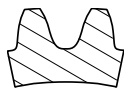

10 D.P.

ALL DIMENSIONS IN INCHES
ORDER BY CATALOG NUMBER OR ITEM CODE

No. of Teeth	Pitch Dia.	Bore	Hub		Style See Page 323	Without Keyway or Setscrew		With Keyway and Setscrew†	
			Dia.	Proj.		Catalog Number	Item Code	Catalog Number	Item Code
12 DIAMETRAL PITCH						Face = 1.000" Outside Dia. = Pitch Dia. + .166" Overall Length = 1.000" + Hub Proj.			
CAST IRON									
60	5.000	.875	2.12	.88	B	YD60	10604	-	-
66	5.500					YD66	10606	-	-
72	6.000					YD72	10608	-	-
84	7.000		YD84	10610		-	-		
96	8.000		YD96	10612		-	-		
108	9.000		2.25	YD108		10614	-	-	
120	10.000	1.000	2.25	.88	D	YD120	10616	-	-
132	11.000					YD132	10618	-	-
144	12.000					YD144	10620	-	-
168	14.000		YD168	10622		-	-		
192	16.000		YD192	10624		-	-		
216	18.000		2.75	YD216		10626	-	-	
10 DIAMETRAL PITCH						Face = 1.250" Outside Dia. = Pitch Dia. + .200" Overall Length = 1.250" + Hub Proj.			
STEEL									
12	1.200	.625	.92	.62	A	YF12	09962	YF12-5/8	46173
14	1.400		1.12	YF14		09964	YF14-5/8	46174	
15	1.500		1.22	YF15		09966	YF15-3/4	46175	
16	1.600		1.32	YF16		09968	YF16-3/4	46176	
18	1.800	.750	1.42	.62		YF18	09970	YF18-3/4	46177
		.875				-	-	YF18-7/8	46178
20	2.000	1.000	1.62	.62		YF20	09972	YF20-7/8	46179
		.875				-	-	YF20-1	46180
24	2.400	1.000	2.02	.62		YF24	09974	YF24-7/8	46181
		.875				-	-	YF24-1	46182
25	2.500	1.000	2.12	.62		YF25	09976	YF25-7/8	46183
		.875				-	-	YF25-1	46184
28	2.800	1.000	2.42	.62		YF28	09978	YF28-7/8	46185
		.875				-	-	YF28-1	46186
30	3.000	.875	2.00	.88		YF30A	10630	-	-
35	3.500		2.50	YF35A		10632	-	-	
40	4.000	1.000	2.95	.88	YF40A	10634	-	-	
45	4.500		3.45	YF45A	10636	-	-		
48	4.800		3.75	YF48A	10638	-	-		
50	5.000		3.95	YF50A	10640	-	-		
CAST IRON									
55	5.500	1.000	2.50	1.00	B	YF55	10642	-	-
60	6.000					YF60	10644	-	-
70	7.000					YF70	10646	-	-
80	8.000					YF80	10648	-	-
90	9.000					YF90	10650	-	-
100	10.000	1.125	3.00	1.12	D	YF100	10652	-	-
120	12.000					YF120	10656	-	-
140	14.000					YF140	10658	-	-
160	16.000					YF160	10660	-	-
200	20.000					3.25	1.25	YF200B	10664

†All gears have standard keyway at 90° to setscrew. See Page 323.

REFERENCE PAGES

- Alterations — 322
- Horsepower Ratings — 59, 60
- Lubrication — 322
- Materials — 323
- Selection Procedure — 49

8 and 6 Diametral Pitch (Steel & Cast Iron)

20° Pressure Angle (will not operate with 14-1/2° spurs)

ALL DIMENSIONS IN INCHES
ORDER BY CATALOG NUMBER OR ITEM CODE

No. of Teeth	Pitch Dia.	Bore	Hub		Style See Page 323	Without Keyway or Setscrew		With Keyway and Setscrew†					
			Dia.	Proj.		Catalog Number	Item Code	Catalog Number	Item Code				
8 DIAMETRAL PITCH													
						Face = 1.500" Outside Dia. = Pitch Dia. + .250" Overall Length = 1.500" + Hub Proj.							
STEEL													
12	1.500	.750	1.12	.75	A	YH12	09980	YH12-3/4	46187				
14	1.750	.750	1.31	.75		YH14	09982	YH14-3/4	46188				
15	1.875	.750 .875	1.43	.75		YH15	09984	YH15-3/4	46189				
						-	-	YH15-7/8	46190				
16	2.000	.875 1.000	1.56	.88		YH16	09986	YH16-7/8	46191				
						-	-	YH16-1	46192				
18	2.250	.875 1.000 1.125	1.81	.88		YH18	09988	YH18-7/8	46193				
						-	-	YH18-1	46194				
						-	-	YH18-1-1/8	46195				
20	2.500	.875 1.000 1.125	2.06	.88		YH20	09990	YH20-7/8	46196				
						-	-	YH20-1	46197				
						-	-	YH20-1-1/8	46198				
22	2.750	.875 1.000 1.125	2.31	.88		YH22	09992	YH22-7/8	46199				
						-	-	YH22-1	46200				
						-	-	YH22-1-1/8	46201				
24	3.000	.875 1.000 1.125	2.56	.88		YH24	09994	YH24-7/8	46202				
					-	-	YH24-1	46203					
					-	-	YH24-1-1/8	46204					
28	3.500	.875	3.06	.88	YH28	09996	-	-					
32	4.000	1.000	3.00	.88	YH32C	10666	-	-					
36	4.500	1.000	3.50	.88	YH36C	10668	-	-					
CAST IRON													
40	5.000	1.000	2.50	1.00	B	YH40B	10670	-	-				
44	5.500					YH44B	10672	-	-				
48	6.000					YH48B	10674	-	-				
56	7.000					YH56B	10676	-	-				
60	7.500				YH60	10678	-	-					
64	8.000				YH64B	10680	-	-					
72	9.000				YH72B	10682	-	-					
80	10.000				1.125	3.00	1.25	D	YH80B	10684	-	-	
88	11.000	YH88B	10686	-					-				
96	12.000	YH96B	10688	-					-				
112	14.000	YH112B	10690	-					-				
120	15.000	YH120	10692	-					-				
128	16.000	YH128B	10694	-					-				
6 DIAMETRAL PITCH													
									Face = 2.000" Outside Dia. = Pitch Dia. + .333" Overall Length = 2.000" + Hub Proj.				
STEEL													
12	2.000	1.000	1.46	.88	A	YJ12	09998	YJ12-1	46205				
14	2.333	1.000 1.125	1.79	.88		YJ14	10000	YJ14-1	46206				
						-	-	YJ14-1-1/8	46207				
15	2.500	1.000 1.125 1.1875 1.250	1.96	.88		YJ15	10002	YJ15-1	46208				
						-	-	YJ15-1-1/8	46209				
						-	-	YJ15-1-3/16	46210				
						-	-	YJ15-1-1/4	46211				

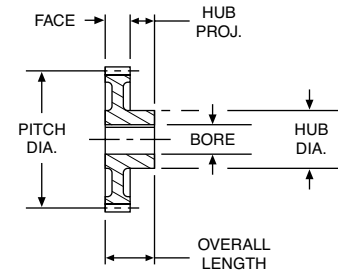
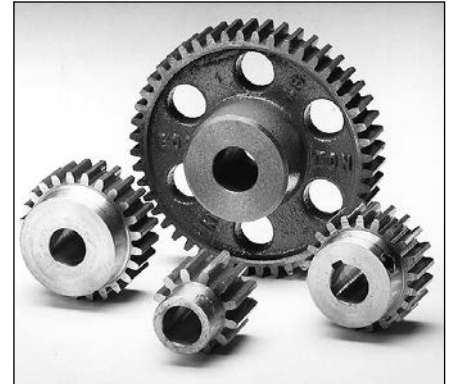

STANDARD TOLERANCES

DIMENSION	TOLERANCE
BORE	All ±.0005

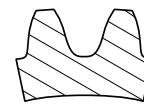

8 D.P.



6 D.P.

†All gears have standard keyway at 90° to setscrew. See Page 323.

REFERENCE PAGES

- Alterations — 322
- Horsepower Ratings — 60, 61
- Lubrication — 322
- Materials — 323
- Selection Procedure — 49

Spur Gears

6 and 5 Diametral Pitch (Steel & Cast Iron)

20° Pressure Angle (will not operate with 14-1/2° spur)

A

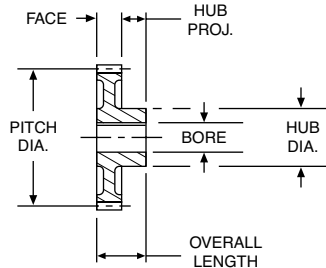

STANDARD TOLERANCES

DIMENSION		TOLERANCE
BORE	All	±.0005

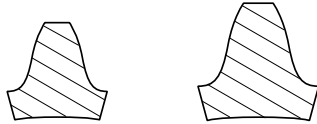

6 D.P.

5 D.P.

REFERENCE PAGES

- Alterations — 322
- Horsepower Ratings — 61, 62
- Lubrication — 322
- Materials — 323
- Selection Procedure — 49

ALL DIMENSIONS IN INCHES
ORDER BY CATALOG NUMBER OR ITEM CODE

No. of Teeth	Pitch Dia.	Bore	Hub		Style See Page 323	Without Keyway or Setscrew		With Keyway and Setscrew†						
			Dia.	Proj.		Catalog Number	Item Code	Catalog Number	Item Code					
6 DIAMETRAL PITCH						Face = 2.000" Outside Dia. = Pitch Dia. + .333" Overall Length = 2.000" + Hub Proj.								
STEEL														
16	2.667	1.000	2.13	.88	A	YJ16	10004	YJ16-1	46212					
		1.125				—	—	YJ16-1-1/8	46213					
		1.1875				—	—	YJ16-1-3/16	46214					
		1.250				—	—	YJ16-1-1/4	46215					
18	3.000	1.000	2.46	.88		YJ18	10006	YJ18-1	46216					
		1.125				—	—	YJ18-1-1/8	46217					
		1.1875				—	—	YJ18-1-3/16	46218					
		1.250				—	—	YJ18-1-1/4	46219					
21	3.500	1.000	2.96	.88		YJ21	10008	YJ21-1	46220					
		1.125				—	—	YJ21-1-1/8	46221					
		1.1875				—	—	YJ21-1-3/16	46222					
24	4.000	1.125	3.00	.88		YJ24A	10704	—	—					
					YJ27A	10706	—	—						
					YJ30C	10708	—	—						
CAST IRON					B	YJ33B	10710	—	—					
						A	YJ36B	10712	—	—				
					42	7.000	1.125	3.50	1.50	B	YJ42B	10714	—	—
											YJ48B	10716	—	—
											YJ54B	10718	—	—
					60	10.000	1.250	4.00	1.50	C	YJ60B	10720	—	—
											YJ66B	10722	—	—
											YJ72B	10724	—	—
										D	YJ84B	10726	—	—
											YJ96B	10728	—	—
											YJ108B	10730	—	—
					120	20.000	1.375	4.50	1.50		YJ120B	10732	—	—
5 DIAMETRAL PITCH						Face = 2.500" Outside Dia. = Pitch Dia. + .400" Overall Length = 2.500" + Hub Proj.								
STEEL														
12	2.400	1.125	1.78	.88	A	YK12	10010	—	—					
						YK14	10012	—	—					
						YK15	10014	—	—					
						YK16	10016	—	—					
						YK18	10018	—	—					
						YK20	10020	—	—					
						CAST IRON					A	YK24	10738	—
YK25B	10740	—	—											
YK28	10742	—	—											
B	YK30B	10744	—	—										
	YK35B	10746	—	—										
	YK40B	10748	—	—										
C	YK45B	10750	—	—										
	YK50B	10752	—	—										
	YK60B	10754	—	—										
D	YK70B	10756	—	—										
	YK80B	10758	—	—										
	YK100B	10762	—	—										
110	22.000	1.375	4.38	1.50	D	YK110B	10764	—	—					
						YK120B	10766	—	—					
						YK140B	10768	—	—					
140	28.000	1.625	5.00	2.00	D	YK160B	10770	—	—					
						YK180B	10772	—	—					
160	32.000	1.625	5.00	2.00	D	YK160B	10770	—	—					
						YK180B	10772	—	—					
180	36.000	1.625	5.50	2.00	D	YK160B	10770	—	—					
						YK180B	10772	—	—					

†All gears have standard keyway at 90° to setscrew. See Page 323.

20 through 4 Diametral Pitch (Steel)

20° Pressure Angle (will not operate with 14-1/2° spurs)

ALL DIMENSIONS IN INCHES
ORDER BY CATALOG NUMBER OR ITEM CODE

Overall Thickness	Pitch Line to Back (B)	Nominal Length (Feet)	Mating Spur Gear Page No.	Steel	
				Catalog Number	Item Code
20 DIAMETRAL PITCH					
				FACE WIDTH - .500"	
.500	.450	4/6	42	L2020-4	12758
				L2020-6	12760
16 DIAMETRAL PITCH					
				FACE WIDTH - .750"	
.750	.688	4/6	43	L2016-4	12762
				L2016-6	12764
12 DIAMETRAL PITCH					
				FACE WIDTH - 1.000"	
1.000	.917	4/6	43 - 44	L2012-4	37320
				L2012-6	37322
10 DIAMETRAL PITCH					
				FACE WIDTH - 1.250"	
1.250	1.150	4/6	44	L2010-4	37316
				L2010-6	37318
8 DIAMETRAL PITCH					
				FACE WIDTH - 1.500"	
1.500	1.375	4/6	45	L208-4	37312
				L208-6	37314
6 DIAMETRAL PITCH					
				FACE WIDTH - 2.000"	
1.500	1.333	4/6	45 - 46	L206-4	37308
				L206-6	37310
5 DIAMETRAL PITCH					
				FACE WIDTH - 2.500"	
1.500	1.300	4/6	46	L205-4	37304
				L205-6	37306
4 DIAMETRAL PITCH					
				FACE WIDTH - 3.500"	
2.000	1.750	4/6	-	L204-4	37300
				L204-6	37302

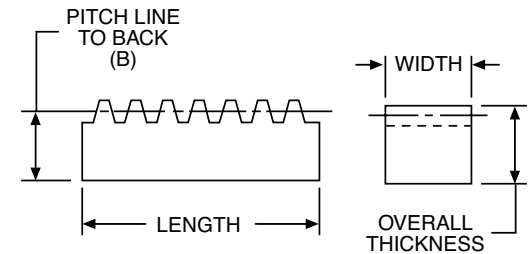
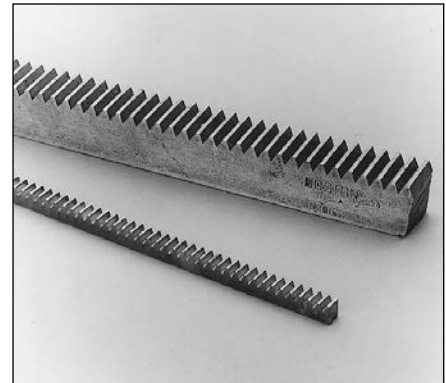

STANDARD TOLERANCES

DIMENSION	TOLERANCE
LENGTH†	All +1.000 - .000
FACE WIDTH	1/2 - 3/4 +.000 - .002
	1 - 1-1/2 +.000 - .003
	2 - 2-1/2 +.000 - .004
	3-1/2 +.000 - .006

†Ends not machined. Tolerance allows for cutting and matching.

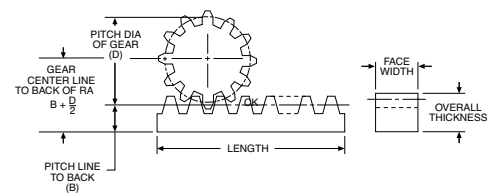

REFERENCE PAGES

- Alterations — 322
- Lubrication — 322
- Materials — 323

Internal Gears

64 through 24 Diametral Pitch (Brass)

20° Pressure Angle (will not operate with 14-1/2° spurs)

A

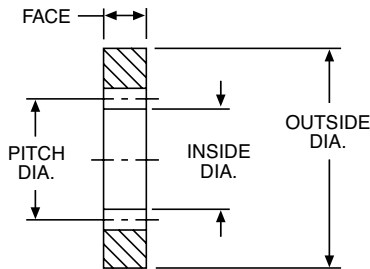
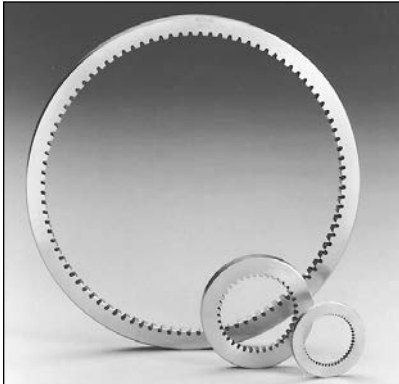

ALL DIMENSIONS IN INCHES
ORDER BY CATALOG NUMBER OR ITEM CODE

No. of Teeth	Pitch Dia.	O.D.	I.D.	Catalog Number	Item Code
64 DIAMETRAL PITCH			FACE WIDTH - .125"		
64	1.000	1.500	.980	YI6464	12030
96	1.500	2.000	1.480	YI6496	12032
128	2.000	2.750	1.980	YI64128	12034
192	3.000	3.750	2.980	YI64192	12036
48 DIAMETRAL PITCH			FACE WIDTH - .125"		
48	1.000	1.500	.974	YI4848	12020
72	1.500	2.000	1.474	YI4872	12022
96	2.000	2.750	1.974	YI4896	12024
144	3.000	3.750	2.974	YI48144	12026
192	4.000	4.750	3.974	YI48192	12028
32 DIAMETRAL PITCH			FACE WIDTH - .188"		
48	1.500	2.000	1.461	YI3248	12010
64	2.000	2.750	1.961	YI3264	12012
96	3.000	3.750	2.961	YI3296	12014
128	4.000	4.750	3.961	YI32128	12016
192	6.000	6.750	5.961	YI32192	12018
24 DIAMETRAL PITCH			FACE WIDTH - .250"		
36	1.500	2.250	1.450	YI2436	12000
48	2.000	2.750	1.950	YI2448	12002
72	3.000	3.750	2.950	YI2472	12004
96	4.000	4.750	3.950	YI2496	12006
144	6.000	6.750	5.950	YI24144	12008

NOTE: The difference in tooth numbers between Gear and Pinion should not be less than 12.

STANDARD TOLERANCES

DIMENSION		TOLERANCE	
I.D.	64 Pitch	All	+.004 - .000
	48 Pitch	All	+.005 - .000
	32 Pitch	All	+.006 - .000
	24 Pitch	All	+.008 - .000
O.D.	All		+.001 + .003

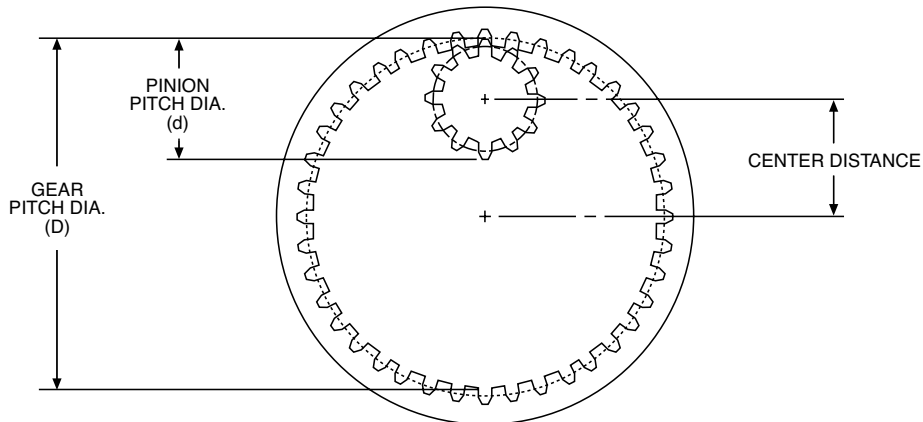

$$\text{CENTER DISTANCE} = \frac{D - d}{2}$$

Boston spur gears are designed to transmit motion or power between parallel shafts. Configurations include spur, rack, pinion wire, stem pinions and internal gears; most with a selection of bores, keyways and setscrews. Styles include plain, web, web with lightening holes or spoked. Change gears have consecutive numbers of teeth for reduction uses.

Boston fine-pitch spur gears are available in Delrin and Brass. Configurations include spur, rack, pinion wire and internal gears; most with a selection of bores, keyways, and setscrews. Styles include plain, web with lightening holes or spoked.

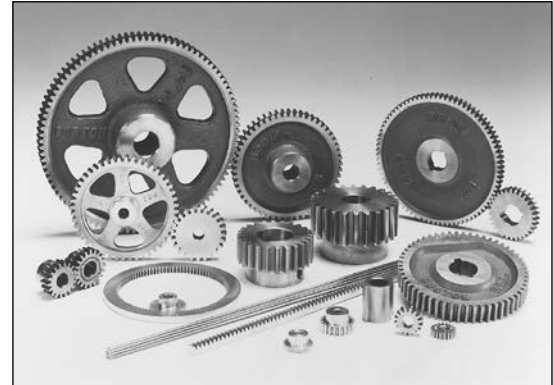

Selection Procedure

1. Determine service factor.
 - a. Using application Classification Chart, pages 331-332, determine service factor or
 - b. With knowledge of operating conditions and load classification, select service factor from Table 1 below.

Design HP = Application Load X Service Factor (Table 1)

3. Select spur gear pinion with horsepower capacity equal to (or greater than) design horsepower determined in Step 2. 14½° Pressure Angle Spur Gears—Page 50 to Page 57. 20° Pressure Angle Spur Gears— Page 58 to Page 62.
4. Select a driven spur gear with a catalog rating equal to or greater than the horsepower determined in Step 2. All ratings are predicated on gears properly lubricated and maintained.

Selection Hints

- A. Select pinion having pitch diameter at least twice the shaft diameter.
- B. Pinion number of teeth should be greater than 16 for 14½°PA and 13 for 20°PA to avoid excessive under-cutting.
- C. For tooth numbers or RPMs not on Chart, interpolation of horsepower is adequate.
- D. Pitchline velocities above 1000 FPM are not recommended for metallic spur gears. The Selection Chart reflects this in the lack of ratings for larger numbers of teeth at higher RPM's. Ratings to the right of heavy line are not recommended, as suggested maximum velocity is exceeded, and should be used for interpolation purposes only.

TABLE 1

Service Factor	Operating Conditions
.8	Uniform — not more than 15 minutes in 2 hours.
1.0	Moderate Shock — not more than 15 minutes in 2 hours. Uniform — not more than 10 hours per day.
1.25	Moderate Shock — not more than 10 hours per day. Uniform — more than 10 hours per day.
1.50	Heavy Shock — not more than 15 minutes in 2 hours. Moderate Shock — more than 10 hours per day.
1.75	Heavy Shock — not more than 10 hours per day.
2.0	Heavy Shock — more than 10 hours per day.

Heavy shock loads and/or severe wear conditions may require the use of higher service factors. Consultation with factory is recommended in these applications.

Spur Gears

Approximate Horsepower and Torque* Ratings

For Class I Service (Service Factor = 1.0)

32 DIAMETRAL PITCH STEEL

14½° PRESSURE ANGLE

3/16" FACE

REFERENCE PAGE 19.

No. Teeth	25 RPM		50 RPM		100 RPM		200 RPM		300 RPM		600 RPM		900 RPM		1200 RPM		1800 RPM		3600 RPM	
	H.P.	Torque	H.P.	Torque	H.P.	Torque	H.P.	Torque	H.P.	Torque	H.P.	Torque	H.P.	Torque	H.P.	Torque	H.P.	Torque	H.P.	Torque
16	.003	7.4	.01	7.3	.01	7.3	.02	7.1	.03	7.0	.06	6.6	.09	6.3	.11	5.9	.15	5.4	.24	4.2
18	.003	8.9	.01	8.8	.01	8.7	.03	8.5	.04	8.3	.07	7.8	.10	7.3	.13	6.9	.18	6.1	.27	4.7
20	.004	10.2	.01	10.2	.02	10.1	.03	9.8	.05	9.6	.08	8.9	.12	8.3	.15	7.8	.20	6.9	.30	5.2
22	.005	11.7	.01	11.6	.02	11.4	.04	11.1	.05	10.8	.09	9.9	.13	9.3	.16	8.7	.22	7.6	.32	5.7
24	.01	13.0	.01	12.9	.02	12.7	.04	12.3	.06	11.9	.10	10.9	.14	10.1	.18	9.4	.24	8.3	.34	6.0
26	.01	14.5	.01	14.4	.02	14.1	.04	13.7	.06	13.3	.12	12.0	.16	11.1	.20	10.2	.26	8.9	.37	6.4
28	.01	15.9	.01	15.1	.02	15.5	.05	14.9	.07	14.5	.12	13.1	.17	12.0	.21	11.0	.27	9.5	.39	6.8
30	.01	17.3	.01	17.0	.03	16.7	.05	16.1	.07	15.5	.13	13.9	.18	12.7	.22	11.7	.29	10.0	.40	7.0
32	.01	18.9	.01	18.7	.03	18.3	.06	17.6	.08	16.9	.14	15.2	.20	13.7	.24	12.6	.31	10.7	.43	7.4
40	.01	24.5	.02	24.2	.04	23.6	.07	22.4	.10	21.3	.18	18.7	.24	16.7	.29	15	.36	12.5	.48	8.4
48	.01	29.9	.02	29.4	.05	28.5	.09	26.8	.12	25.4	.21	21.8	.27	19.1	.32	17	.40	13.9	.52	9.0
56	.01	35.7	.03	35	.05	33.8	.10	31.5	.14	29.6	.24	24.9	.31	21.6	.36	18.9	.44	15.3	.55	9.7
64	.02	41.4	.03	40.6	.06	38.9	.11	36	.16	33.5	.26	27.8	.34	23.7	.39	20.7	.47	16.5	.58	10.2
80	.02	52.4	.04	51	.08	48.5	.14	44.2	.19	40.6	.31	32.5	.39	27.2	.44	23.3	.52	18.2		
96	.02	62.6	.05	60.6	.09	57.1	.16	51.2	.22	46.4	.34	36.2	.42	29.6	.48	25.1	.55	19.2		
128	.03	83.9	.06	80.6	.12	74.6	.21	64.9	.27	57.5	.41	42.7	.49	34	.54	28.3				
160	.04	106	.08	101	.15	92.1	.25	78.2	.32	67.8	.46	48.6	.54	37.9						
192	.05	126	.09	119	.17	107	.28	88.4	.36	75.4	.50	52.4	.57	40.1						

24 DIAMETRAL PITCH STEEL

14½° PRESSURE ANGLE

1/4" FACE

REFERENCE PAGE 20.

No. Teeth	25 RPM		50 RPM		100 RPM		200 RPM		300 RPM		600 RPM		900 RPM		1200 RPM		1800 RPM		3600 RPM	
	H.P.	Torque	H.P.	Torque	H.P.	Torque	H.P.	Torque	H.P.	Torque	H.P.	Torque	H.P.	Torque	H.P.	Torque	H.P.	Torque	H.P.	Torque
12	.004	10.9	.01	10.8	.02	10.7	.03	10.5	.05	10.3	.09	9.7	.13	9.2	.17	8.7	.22	7.9	.35	6.1
14	.01	14.2	.01	14.1	.02	13.9	.04	13.6	.06	13.3	.12	12.4	.17	11.6	.23	10.9	.28	9.8	.43	7.5
15	.01	15.8	.01	15.7	.02	15.5	.05	15.1	.07	14.7	.13	13.7	.18	12.8	.23	12	.31	10.7	.46	8.0
16	.01	17.5	.01	17.4	.03	17.2	.05	16.7	.08	16.2	.14	15	.20	14	.25	13.1	.33	11.6	.49	8.6
18	.01	20.9	.02	20.7	.03	20.4	.06	19.8	.09	19.2	.17	17.6	.23	16.3	.29	15.1	.38	13.3	.55	9.7
20	.01	24.3	.02	24.1	.04	23.7	.07	22.9	.11	22.1	.19	20.1	.26	18.5	.33	17.1	.42	14.8	.61	10.6
21	.01	26.1	.02	25.8	.04	25.4	.08	24.5	.11	23.6	.20	21.4	.28	19.6	.34	18.1	.45	15.6	.63	11.0
24	.01	30.7	.02	30.4	.05	29.7	.09	28.5	.13	27.5	.23	24.6	.32	22.3	.39	20.4	.50	17.4	.69	12.0
30	.02	40.7	.03	40.2	.06	39.2	.12	37.2	.17	35.5	.30	31.1	.40	27.7	.48	24.9	.60	20.8	.80	13.9
36	.02	51.2	.04	50.4	.08	48.8	.15	46	.21	43.5	.36	37.3	.47	32.7	.55	29.1	.68	23.9	.89	15.5
42	.02	60.7	.05	59.6	.09	59.5	.17	53.6	.24	50.3	.40	42.4	.52	36.6	.61	32.3	.74	26	.94	16.5
48	.03	70.4	.05	68.9	.11	66.2	.19	61.3	.27	57	.45	47.2	.58	40.3	.67	35.1	.80	28	.99	17.4
60	.04	90	.07	87.7	.13	83.3	.24	75.9	.33	69.6	.53	55.9	.67	46.6	.76	40	.89	31.2		
72	.04	109	.08	106	.16	99.8	.28	89.5	.39	81	.60	63.2	.74	51.8	.84	43.9	.96	33.6		
96	.06	147	.11	141	.21	130	.36	113	.48	100	.71	74.7	.85	59.5	.94	49.5				
120	.07	185	.14	175	.25	159	.43	135	.56	118	.80	84.3	.94	65.7	1.07	56.4				
144	.09	219	.16	207	.29	185	.49	153	.62	131	.86	90.8	.99	69.6						

Ratings are based on strength calculation. Basic static strength rating, or for hand operation of above gears is approximately 3 times the 100 RPM rating.

NOTE: Ratings to right of heavy line are not recommended, as pitch line velocity exceeds 1000 feet per minute. They should be used for interpolation purposes only.

* Torque Ratings (Lb. Ins.).

Ratings for brass gears are approximately 50% of steel ratings with same face width.

Approximate Horsepower and Torque* Ratings

For Class I Service (Service Factor = 1.0)

20 DIAMETRAL PITCH STEEL

14½° PRESSURE ANGLE

3/8" FACE

REFERENCE PAGE 20.

No. Teeth	25 RPM		50 RPM		100 RPM		200 RPM		300 RPM		600 RPM		900 RPM		1200 RPM		1800 RPM		3600 RPM	
	H.P.	Torque	H.P.	Torque	H.P.	Torque	H.P.	Torque	H.P.	Torque	H.P.	Torque	H.P.	Torque	H.P.	Torque	H.P.	Torque	H.P.	Torque
11	.01	21.6	.02	21.4	.03	21.2	.07	20.7	.10	20.2	.18	18.9	.25	17.8	.32	16.8	.43	15.1	.66	11.6
12	.01	23.5	.02	23.4	.04	23	.07	22.5	.10	21.9	.19	20.5	.27	19.2	.34	18	.46	16.1	.70	12.2
13	.01	26.9	.02	26.8	.04	26.4	.08	25.7	.12	25	.22	23.2	.31	21.6	.39	20.3	.51	17.9	.77	13.4
14	.01	30.7	.02	30.5	.05	30	.09	29.1	.13	28.3	.25	26.1	.35	24.2	.43	22.6	.57	20	.84	14.7
15	.01	34.2	.03	33.9	.05	33.4	.10	32.3	.15	31.4	.27	28.8	.38	26.6	.47	24.7	.62	21.7	.90	15.8
16	.02	37.8	.03	37.5	.06	36.8	.11	35.7	.16	34.5	.30	31.6	.41	29	.51	26.9	.67	23.4	.97	16.9
18	.02	45.1	.04	44.7	.07	43.8	.13	42.3	.19	40.8	.35	36.9	.48	33.7	.59	31	.76	26.7	1.08	18.9
20	.02	52.4	.04	51.9	.08	50.8	.15	48.7	.22	46.9	.40	42	.54	38	.66	34.8	.85	29.7	1.18	20.6
22	.02	59.5	.05	58.8	.09	57.5	.17	54.9	.25	52.7	.45	46.8	.60	42	.73	38.2	.92	32.3	1.26	22.1
24	.03	66.3	.05	65.4	.10	63.8	.19	60.8	.28	58	.49	51.1	.65	45.6	.78	41.2	.99	34.6	1.33	23.3
25	.03	70.5	.06	69.5	.11	67.7	.20	64.4	.29	61.4	.51	53.8	.68	47.9	.82	43.1	1.03	36	1.38	24.0
28	.03	81.2	.06	80	.12	77.7	.23	73.4	.33	69.7	.57	60.3	.76	53.2	.91	47.5	1.12	39.2	1.47	25.7
30	.03	87.8	.07	86.4	.13	83.7	.25	78.9	.36	74.6	.61	64	.80	56.1	.95	50	1.17	40.9	1.52	26.6
32	.04	96.3	.08	94.7	.15	91.6	.27	86	.39	81	.66	69.1	.86	60.2	1.02	53.3	1.24	43.4	1.59	27.8
35	.04	107	.08	105	.16	101	.30	94.7	.42	88.9	.71	74.9	.92	64.7	1.09	57	1.31	46	1.66	29.1
36	.04	110	.09	108	.17	104	.31	97.1	.43	91	.73	76.4	.94	65.8	1.10	57.8	1.33	46.5	1.68	29.3
40	.05	124	.10	122	.19	117	.34	108	.48	101	.79	83.5	1.02	71.2	1.18	62.1	1.41	49.4	1.75	30.7
48	.06	151	.12	148	.22	141	.41	128	.56	118	.91	95.4	1.14	80	1.31	69.8	1.54	53.8		
50	.06	158	.12	154	.23	146	.42	133	.58	122	.93	98	1.17	81.7	1.34	70.1	1.56	54.6		
60	.08	193	.15	187	.28	176	.50	158	.68	143	1.06	112	1.31	91.6	1.48	77.6	1.70	59.5		
64	.08	209	.16	203	.30	190	.54	169	.73	153	1.12	118	1.37	96	1.54	80.9				

A

20 DIAMETRAL PITCH CAST IRON

14½° PRESSURE ANGLE

3/8" FACE

REFERENCE PAGE 21.

No. Teeth	25 RPM		50 RPM		100 RPM		200 RPM		300 RPM		600 RPM		900 RPM		1200 RPM		1800 RPM		3600 RPM	
	H.P.	Torque	H.P.	Torque	H.P.	Torque	H.P.	Torque	H.P.	Torque	H.P.	Torque	H.P.	Torque	H.P.	Torque	H.P.	Torque	H.P.	Torque
70	.05	137	.10	132	.20	123	.35	109	.46	97.5	.71	74.2	.86	60	.96	50.2				
72	.06	140	.11	136	.20	126	.35	111	.47	99.4	.72	75.3	.87	60.6	.97	50.7				
80	.06	158	.12	152	.22	141	.39	123	.52	108	.77	80.7	.92	64.3	1.02	53.4				
84	.07	166	.13	159	.23	147	.40	127	.53	112	.79	82.7	.94	65.5	1.03	54.3				
90	.07	177	.13	169	.25	155	.42	133	.56	117	.81	85.4	.96	67.2						
96	.07	189	.14	180	.26	164	.44	140	.58	122	.84	87.9	.98	68.8						
100	.08	196	.15	186	.27	170	.46	144	.59	125	.85	89.5	1.00	69.7						
112	.09	222	.17	210	.30	189	.50	158	.65	136	.91	95.5	1.05	73.6						
120	.09	237	.18	223	.32	200	.53	166	.67	141	.93	98.1	1.07	75.1						
140	.11	273	.20	255	.36	225	.58	183	.73	153	.99	104								
144	.11	281	.21	262	.37	230	.59	186	.74	156	1.00	105								
160	.13	317	.23	294	.41	256	.64	203	.80	168	1.06	111								
180	.14	353	.26	324	.44	278	.69	217	.85	178	1.10	115								
200	.15	388	.28	354	.48	300	.73	230	.89	187	1.13	119								

Ratings are based on strength calculation. Basic static strength rating, or for hand operation of above gears is approximately 3 times the 100 RPM rating.

NOTE: Ratings to right of heavy line are not recommended, as pitch line velocity exceeds 1000 feet per minute. They should be used for interpolation purposes only.

*Torque Ratings (Lb. Ins.).

Spur Gears

Approximate Horsepower and Torque* Ratings

For Class I Service (Service Factor = 1.0)

16 DIAMETRAL PITCH STEEL 14½° PRESSURE ANGLE 1/2" FACE REFERENCE PAGE 21 & 22.

No. Teeth	25 RPM		50 RPM		100 RPM		200 RPM		300 RPM		600 RPM		900 RPM		1200 RPM		1800 RPM		3600 RPM	
	H.P.	Torque	H.P.	Torque	H.P.	Torque	H.P.	Torque	H.P.	Torque	H.P.	Torque	H.P.	Torque	H.P.	Torque	H.P.	Torque	H.P.	Torque
11	.02	44.9	.04	44.5	.07	43.9	.14	42.7	.20	41.5	.36	38.3	.51	35.6	.63	33.2	.84	29.4	1.24	21.7
12	.02	48.9	.04	48.5	.08	47.8	.15	46.3	.21	44.9	.39	41.2	.54	38.1	.67	35.4	.89	31	1.29	22.6
13	.02	56.1	.04	55.6	.09	54.7	.17	52.9	.24	51.2	.44	46.7	.61	42.9	.76	39.7	.99	34.6	1.42	24.9
14	.03	63.8	.05	63.2	.10	62	.19	59.8	.28	57.8	.50	52.4	.68	47.9	.84	44.2	1.09	38.2	1.55	27.1
15	.03	71.1	.06	70.3	.11	68.9	.21	66.4	.30	63.9	.55	57.6	.75	52.5	.92	48.1	1.18	41.3	1.66	29.0
16	.03	78.7	.06	77.8	.12	76.2	.23	73.1	.33	70.3	.60	63	.82	57.1	.99	52.2	1.27	44.5	1.77	30.9
18	.04	93.8	.07	99.6	.14	90.5	.27	86.5	.39	82.8	.70	73.4	.94	65.9	1.14	59.8	1.44	50.4	1.96	34.3
20	.04	109	.09	107	.17	105	.32	99	.45	94.9	.79	83.2	1.06	74.1	1.27	66.7	1.59	55.7	2.13	37.2
22	.05	124	.10	122	.19	118	.36	112	.51	106	.88	92.3	1.16	81.5	1.39	72.9	1.72	60.3	2.27	39.7
24	.05	138	.11	135	.21	131	.39	124	.56	117	.96	100	1.26	88	1.49	78.3	1.83	64.2	2.38	41.7
26	.06	154	.12	151	.23	146	.43	137	.61	129	1.04	110	1.36	95.4	1.61	84.4	1.96	68.6	2.51	43.9
28	.07	168	.13	165	.25	160	.47	149	.66	140	1.12	118	1.45	102	1.71	89.6	2.06	72.3	2.62	45.8
30	.07	182	.14	179	.27	172	.51	160	.71	149	1.19	125	1.53	107	1.79	93.8	2.15	75.1	2.69	47.1
32	.08	200	.16	196	.30	188	.55	174	.77	162	1.28	134	1.63	114	1.90	99.7	2.27	79.4	2.81	49.3
36	.09	228	.18	223	.34	213	.62	196	.86	181	1.40	147	1.77	124	2.05	107	2.42	84.6		
40	.10	258	.20	251	.38	239	.69	217	.95	200	1.52	160	1.91	134	2.18	115	2.55	89.4		
48	.12	314	.24	304	.45	286	.81	257	1.11	232	1.73	181	2.12	149	2.40	126	2.76	96.5		

16 DIAMETRAL PITCH CAST IRON 14½° PRESSURE ANGLE 1/2" FACE REFERENCE PAGE 22.

No. Teeth	25 RPM		50 RPM		100 RPM		200 RPM		300 RPM		600 RPM		900 RPM		1200 RPM		1800 RPM		3600 RPM	
	H.P.	Torque	H.P.	Torque	H.P.	Torque	H.P.	Torque	H.P.	Torque	H.P.	Torque	H.P.	Torque	H.P.	Torque	H.P.	Torque	H.P.	Torque
54	.09	217	.17	209	.31	196	.55	173	.74	156	1.13	119	1.38	96.6	1.54	81.1				
56	.09	224	.17	216	.32	202	.57	178	.76	160	1.16	121	1.40	98.1	1.57	82.2				
60	.10	239	.18	231	.34	214	.60	188	.80	167	1.20	126	1.44	100	1.60	84.2				
64	.10	260	.20	249	.37	231	.64	201	.85	178	1.26	132	1.50	105	1.67	87.5				
72	.12	290	.22	277	.40	255	.69	219	.91	192	1.33	140	1.57	110						
80	.13	327	.25	311	.45	283	.76	240	.99	208	1.42	149	1.66	116						
84	.14	342	.26	325	.47	294	.79	248	1.02	214	1.45	152	1.69	118						
96	.15	388	.29	365	.52	327	.86	271	1.10	231	1.53	161	1.76	123						
112	.18	455	.34	425	.60	376	.97	304	1.22	256	1.65	173								
120	.19	486	.36	452	.63	396	1.01	318	1.26	265	1.69	177								
128	.20	516	.38	477	.66	415	1.05	330	1.30	274	1.72	181								
144	.23	574	.42	527	.72	453	1.12	353	1.38	289	1.79	188								
160	.26	648	.47	590	.79	500	1.22	384	1.48	311	1.89	198								
192	.307	762	.54	683	.90	566	1.34	421	1.60	335										

16 DIAMETRAL PITCH NON-METALLIC 14½° PRESSURE ANGLE 1/2" FACE REFERENCE PAGE 22.

No. Teeth	25 RPM		50 RPM		100 RPM		200 RPM		300 RPM		600 RPM		900 RPM		1200 RPM		1800 RPM		3600 RPM	
	H.P.	Torque	H.P.	Torque	H.P.	Torque	H.P.	Torque	H.P.	Torque	H.P.	Torque	H.P.	Torque	H.P.	Torque	H.P.	Torque	H.P.	Torque
16							.06	19	.09	19	.15	16	.20	14	.25	13	.32	11	.56	9
20							.09	28	.12	30	.20	21	.26	18	.32	17	.42	15	.69	12
24							.11	34	.15	31	.24	25	.31	22	.38	20	.50	17	.82	14
32							.14	44	.19	40	.31	32	.40	28	.49	26	.65	23	1.12	20
40							.18	57	.24	50	.38	40	.49	34	.62	32	.82	29	1.41	25
48							.21	63	.28	58	.44	46	.60	40	.72	37	.96	33	1.65	29
64							.26	82	.34	71	.54	57	.72	50	.88	46	1.20	42		

Ratings are based on strength calculation. Basic static strength rating, or for hand operation of above gears is approximately 3 times the 100 RPM rating.

NOTE: 1. Ratings to right of heavy line are not recommended, as pitch line velocity exceeds 1000 feet per minute.

They should be used for interpolation purposes only.

2. Non-metallic gears are most commonly used for the driving pinion of a pair of gears, with mating gear made of Cast Iron or Steel, where pitch line velocities exceed 1000 FPM and are not subjected to shock loads.

*Torque Ratings (Lb. Ins.).

Approximate Horsepower and Torque* Ratings

For Class I Service (Service Factor = 1.0)

12 DIAMETRAL PITCH STEEL

14½° PRESSURE ANGLE

¾" FACE

REFERENCE PAGE 22.

No. Teeth	25 RPM		50 RPM		100 RPM		200 RPM		300 RPM		600 RPM		900 RPM		1200 RPM		1800 RPM		3600 RPM	
	H.P.	Torque	H.P.	Torque	H.P.	Torque	H.P.	Torque	H.P.	Torque	H.P.	Torque	H.P.	Torque	H.P.	Torque	H.P.	Torque	H.P.	Torque
11	.05	119	.09	118	.18	116	.35	112	.51	108	.93	97	1.27	88.6	1.55	81.5	2.00	70	2.82	49.4
12	.05	130	.10	129	.20	126	.38	120	.55	116	.99	104	1.35	94.4	1.64	86.3	2.10	73.6	2.92	51.1
13	.06	149	.12	147	.23	144	.44	138	.63	132	1.12	118	1.51	106	1.83	96.3	2.33	81.6	3.19	55.9
14	.07	169	.13	167	.26	163	.49	156	.71	149	1.25	131	1.68	118	2.03	107	2.56	89.6	3.46	60.6
15	.07	189	.15	186	.29	181	.55	172	.78	164	1.37	144	1.83	128	2.20	116	2.76	96.6	3.69	64.6
16	.08	209	.16	206	.32	200	.60	190	.86	180	1.50	157	1.99	139	2.38	125	2.96	103	3.91	68.5
18	.10	249	.19	245	.38	237	.71	224	1.01	242	1.73	182	2.28	159	2.70	142	3.32	116	4.31	75.4
20	.11	289	.23	284	.44	274	.82	257	1.15	215	1.95	205	2.54	178	2.99	157	3.64	127	4.65	81.4
21	.12	310	.24	304	.47	293	.87	274	1.22	257	2.06	216	2.67	187	3.14	164	3.80	133	4.81	84.3
22	.13	328	.26	322	.49	310	.92	288	1.28	270	2.15	226	2.78	195	3.25	171	3.92	137	4.93	86.2
24	.14	365	.28	357	.54	343	1.01	317	1.41	296	2.33	245	2.98	209	3.47	182	4.14	145	5.14	90.0
30	.19	483	.37	470	.71	447	1.29	407	1.78	373	2.85	299	3.57	250	4.09	215	4.78	167		
32	.21	529	.41	514	.77	488	1.40	442	1.92	403	3.05	320	3.80	266	4.32	227	5.02	176		
36	.24	605	.46	586	.88	552	1.57	495	2.13	448	3.33	349	4.09	286	4.62	243	5.31	186		
40	.27	682	.52	659	.98	617	1.74	547	2.34	492	3.59	377	4.37	306	4.90	257				
42	.28	715	.55	689	1.02	644	1.80	568	2.42	509	3.69	387	4.46	312	4.99	262				

A

12 DIAMETRAL PITCH CAST IRON

14½° PRESSURE ANGLE

¾" FACE

REFERENCE PAGE 23.

No. Teeth	25 RPM		50 RPM		100 RPM		200 RPM		300 RPM		600 RPM		900 RPM		1200 RPM		1800 RPM		3600 RPM	
	H.P.	Torque	H.P.	Torque	H.P.	Torque	H.P.	Torque	H.P.	Torque	H.P.	Torque	H.P.	Torque	H.P.	Torque	H.P.	Torque	H.P.	Torque
48	.20	497	.38	477	.70	441	1.22	384	1.62	340	2.41	253	2.88	201	3.19	167				
54	.23	571	.43	545	.79	500	1.36	430	1.79	377	2.62	275	3.09	216	3.40	178				
60	.25	631	.48	600	.87	546	1.47	463	1.91	402	2.74	288	3.21	224						
64	.27	683	.51	647	.93	586	1.56	493	2.02	425	2.87	301	3.33	233						
72	.30	762	.57	718	1.02	644	1.69	533	2.17	455	3.01	316	3.46	242						
84	.36	896	.66	837	1.17	739	1.90	598	2.40	503	3.24	340								
96	.40	1014	.74	938	1.30	817	2.06	649	2.56	538	3.39	356								
108	.46	1148	.84	1054	1.44	906	2.24	706	2.76	579	3.58	376								
112	.47	1187	.86	1087	1.47	929	2.29	720	2.80	588	3.62	379								
120	.50	1264	.91	1150	1.55	975	2.37	748	2.89	607	3.69	387								
144	.59	1487	1.06	1333	1.75	1103	2.61	821	3.11	654	3.86	406								
168	.69	1745	1.22	1541	1.98	1248	2.87	905	3.38	710										

12 DIAMETRAL PITCH NON-METALLIC

14½° PRESSURE ANGLE

¾" FACE

REFERENCE PAGE 23.

No. Teeth	25 RPM		50 RPM		100 RPM		200 RPM		300 RPM		600 RPM		900 RPM		1200 RPM		1800 RPM		3600 RPM	
	H.P.	Torque	H.P.	Torque	H.P.	Torque	H.P.	Torque	H.P.	Torque	H.P.	Torque	H.P.	Torque	H.P.	Torque	H.P.	Torque	H.P.	Torque
15							.13	41	.20	42	.34	36	.45	31	.56	29	.72	25	1.15	20
18							.19	60	.26	54	.43	45	.56	39	.68	36	.90	31	1.44	25
21							.23	72	.31	65	.50	52	.66	46	.81	42	1.06	37	1.80	31
24							.27	85	.36	76	.58	60	.76	53	.92	48	1.22	42	2.07	36
30							.34	107	.44	92	.73	76	.95	66	1.14	60	1.56	54	2.64	46
36							.40	126	.52	109	.82	86	1.13	79	1.36	71	1.83	64	3.18	56
48							.51	161	.66	138	1.05	110	1.39	97	1.70	89	2.33	81		
60							.60	189	.80	168	1.29	135	1.72	120	2.13	112	2.95	103		

Ratings are based on strength calculation. Basic static strength rating, or for hand operation of above gears is approximately 3 times the 100 RPM rating.

NOTE: 1. Ratings to right of heavy line are not recommended, as pitch line velocity exceeds 1000 feet per minute. They should be used for interpolation purposes only.

2. Non-metallic gears are most commonly used for the driving pinion of a pair of gears, with mating gear made of Cast Iron or Steel, where pitch line velocities exceed 1000 FPM and are not subjected to shock loads.

*Torque Ratings (Lb. Ins.).

Spur Gears

Approximate Horsepower and Torque* Ratings

For Class I Service (Service Factor = 1.0)

10 DIAMETRAL PITCH STEEL

14½° PRESSURE ANGLE

1" FACE

REFERENCE PAGE 23.

No. Teeth	25 RPM		50 RPM		100 RPM		200 RPM		300 RPM		600 RPM		900 RPM		1200 RPM		1800 RPM		3600 RPM	
	H.P.	Torque	H.P.	Torque	H.P.	Torque	H.P.	Torque	H.P.	Torque	H.P.	Torque	H.P.	Torque	H.P.	Torque	H.P.	Torque	H.P.	Torque
11	.09	229	.18	226	.35	221	.67	211	.96	202	1.71	179	2.31	162	2.80	147	3.55	124	4.85	85
12	.10	249	.20	246	.38	240	.73	229	1.04	218	1.83	192	2.45	172	2.95	155	3.71	130	5.00	88
14	.13	325	.25	320	.49	311	.93	294	1.33	279	2.30	241	3.04	213	3.62	190	4.49	157	5.89	103
15	.14	362	.28	356	.55	345	1.03	325	1.46	307	2.51	264	3.30	231	3.92	206	4.82	169	6.25	109
16	.16	400	.31	393	.60	381	1.13	357	1.60	337	2.73	287	3.57	250	4.22	221	5.15	180	6.62	116
18	.19	447	.37	468	.72	451	1.33	420	1.87	394	3.15	330	4.07	285	4.76	250	5.75	201	7.25	127
20	.22	553	.43	542	.83	520	1.53	481	2.13	448	3.53	371	4.52	317	5.26	276	6.28	220	7.79	136
24	.28	698	.54	681	1.03	648	1.88	592	2.59	545	4.19	440	5.26	369	6.04	317	7.09	248		
25	.29	742	.57	722	1.09	687	1.98	625	2.73	574	4.38	460	5.49	384	6.28	330	7.34	257		
28	.34	854	.66	829	1.24	784	2.24	707	3.06	644	4.83	507	5.98	419	6.79	357	7.85	275		
30	.37	922	.71	893	1.34	842	2.39	754	3.25	683	5.07	533	6.24	437	7.05	370	8.10	283		
32	.40	1010	.78	977	1.46	917	2.59	817	3.51	737	5.41	569	6.61	463	7.44	391				
35	.45	1123	.86	1083	1.60	1011	2.83	893	3.80	799	5.79	608	7.01	491	7.83	411				
36	.46	1153	.88	1111	1.64	1036	2.89	912	3.88	815	5.87	617	7.09	496	7.91	415				

10 DIAMETRAL PITCH CAST IRON

14½° PRESSURE ANGLE

1" FACE

REFERENCE PAGE 24.

No. Teeth	25 RPM		50 RPM		100 RPM		200 RPM		300 RPM		600 RPM		900 RPM		1200 RPM		1800 RPM		3600 RPM	
	H.P.	Torque	H.P.	Torque	H.P.	Torque	H.P.	Torque	H.P.	Torque	H.P.	Torque	H.P.	Torque	H.P.	Torque	H.P.	Torque	H.P.	Torque
40	.31	780	.59	749	1.10	693	1.92	603	2.54	534	3.79	398	4.52	317	5.01	263				
42	.32	818	.62	783	1.15	722	1.99	626	2.63	552	3.88	407	4.61	323	5.09	267				
45	.35	889	.67	850	1.24	780	2.13	670	2.79	587	4.08	428	4.81	337						
48	.38	946	.71	901	1.31	823	2.23	701	2.91	611	4.20	441	4.92	345						
50	.39	983	.74	935	1.35	851	2.29	722	2.98	626	4.27	449	4.99	350						
54	.43	1083	.82	1029	1.48	931	2.48	782	3.21	674	4.53	476	5.26	368						
55	.44	1105	.83	1046	1.50	945	2.51	791	3.24	681	4.57	480	5.29	371						
60	.48	1199	.90	1130	1.61	1013	2.66	839	3.41	716	4.73	497	5.43	381						
64	.51	1297	.97	1217	1.72	1084	2.82	890	3.59	755	4.93	518								
70	.56	1410	1.04	1316	1.84	1162	2.99	942	3.77	792	5.10	535								
72	.57	1447	1.07	1349	1.88	1187	3.04	958	3.82	803	5.15	541								
80	.64	1623	1.19	1502	2.07	1308	3.30	1039	4.10	861	5.43	570								
84	.67	1697	1.24	1565	2.15	1355	3.39	1069	4.10	882	5.51	579								
90	.72	1807	1.32	1659	2.26	1425	3.53	1111	4.34	911	5.63	591								
96	.76	1916	1.39	1750	2.37	1492	3.65	1152	4.46	938	5.73	602								
100	.79	1988	1.44	1810	2.44	1535	3.74	1177	4.54	955	5.80	609								
110	.87	2203	1.58	1990	2.64	1667	3.99	1258	4.81	1011	6.05	636								
120	.94	2380	1.69	2133	2.80	1766	4.17	1314	4.98	1047	6.18	650								
140	1.08	2724	1.91	2405	3.09	1949	4.48	1413	5.27	1108										
144	1.11	2791	1.95	2457	3.15	1983	4.54	1430	5.33	1119										
160	1.24	3132	2.16	2727	3.44	2166	4.87	1535	5.66	1188										
180	1.37	3459	2.36	2971	3.68	2318	5.11	1609	5.87	1233										

10 DIAMETRAL PITCH NON-METALLIC

14½° PRESSURE ANGLE

1" FACE

REFERENCE PAGE 23.

No. Teeth	25 RPM		50 RPM		100 RPM		200 RPM		300 RPM		600 RPM		900 RPM		1200 RPM		1800 RPM		3600 RPM	
	H.P.	Torque	H.P.	Torque	H.P.	Torque	H.P.	Torque	H.P.	Torque	H.P.	Torque	H.P.	Torque	H.P.	Torque	H.P.	Torque	H.P.	Torque
15							.27	85	.38	80	.63	66	.83	58	1.00	52	1.31	46	2.08	36
18							.33	104	.47	99	.78	82	1.02	71	1.24	65	1.63	57	2.60	45
20							.40	126	.54	113	.88	92	1.15	80	1.39	73	1.85	65	3.12	55
25							.51	161	.67	140	1.09	114	1.42	99	1.73	90	2.32	81	4.00	70
30							.62	195	.81	170	1.29	135	1.69	118	2.07	109	2.80	98	4.89	86

Ratings are based on strength calculation. Basic static strength rating, or for hand operation of above gears is approximately 3 times the 100 RPM rating.

NOTE: 1. Ratings to right of heavy line are not recommended, as pitch line velocity exceeds 1000 feet per minute. They should be used for interpolation purposes only.

2. Non-metallic gears are most commonly used for the driving pinion of a pair of gears, with mating gear made of Cast Iron or Steel, where pitch line velocities exceed 1000 FPM and are not subjected to shock loads.

*Torque Ratings (Lb. Ins.).

Approximate Horsepower and Torque* Ratings

For Class I Service (Service Factor = 1.0)

8 DIAMETRAL PITCH STEEL 14½° PRESSURE ANGLE 1-1/4" FACE REFERENCE PAGE 24.

No. Teeth	25 RPM		50 RPM		100 RPM		200 RPM		300 RPM		600 RPM		900 RPM		1200 RPM		1800 RPM		3600 RPM	
	H.P.	Torque	H.P.	Torque	H.P.	Torque	H.P.	Torque	H.P.	Torque	H.P.	Torque	H.P.	Torque	H.P.	Torque	H.P.	Torque	H.P.	Torque
11	.18	446	.35	439	.68	427	1.28	404	1.82	383	3.16	332	4.19	294	5.00	263	6.21	217	8.17	143
12	.19	485	.38	478	.73	463	1.38	436	1.96	412	3.37	354	4.43	310	5.26	276	6.47	226	8.39	147
14	.25	632	.49	620	.95	599	1.77	559	2.49	524	4.21	442	5.45	382	6.40	336	7.75	271	9.81	172
15	.28	703	.55	690	1.05	664	1.96	617	2.74	576	4.58	481	5.90	413	6.89	362	8.29	290	10.39	182
16	.31	778	.60	762	1.16	731	2.15	677	3.00	630	4.97	522	6.36	445	7.39	388	8.83	309	10.96	192
18	.37	927	.72	905	1.37	865	2.52	794	3.49	734	5.69	598	7.20	504	8.30	436	9.80	343		
20	.43	1075	.83	1047	1.58	996	2.88	907	3.96	832	6.35	667	7.96	557	9.10	478	10.64	372		
22	.48	1219	.94	1184	1.78	1121	3.21	1012	4.39	923	6.95	730	8.62	603	9.79	514	11.34	397		
24	.54	1355	1.04	1313	1.96	1237	3.52	1109	4.78	1004	7.46	783	9.17	642	10.36	544	11.90	417		
28	.66	1655	1.27	1596	2.37	1490	4.18	1316	5.61	1178	8.53	896	10.33	723	11.54	606				
30	.71	1786	1.36	1718	2.53	1598	4.44	1400	5.93	1247	8.93	938	10.73	752	11.94	627				
32	.78	1957	1.49	1878	2.76	1738	4.80	1513	6.38	1340	9.49	997	11.34	794	12.56	660				

8 DIAMETRAL PITCH CAST IRON 14½° PRESSURE ANGLE 1-1/4" FACE REFERENCE PAGE 25.

No. Teeth	25 RPM		50 RPM		100 RPM		200 RPM		300 RPM		600 RPM		900 RPM		1200 RPM		1800 RPM		3600 RPM	
	H.P.	Torque	H.P.	Torque	H.P.	Torque	H.P.	Torque	H.P.	Torque	H.P.	Torque	H.P.	Torque	H.P.	Torque	H.P.	Torque	H.P.	Torque
36	.53	1339	1.01	1279	1.86	1174	3.20	1009	4.21	884	6.14	645	7.25	507						
40	.60	1508	1.14	1434	2.07	1305	3.51	1107	4.57	961	6.55	688	7.66	536						
42	.63	1579	1.19	1498	2.16	1358	3.63	1145	4.71	989	6.69	703	7.78	545						
44	.67	1681	1.26	1591	2.28	1437	3.82	1204	4.93	1036	6.95	730	8.05	564						
48	.72	1824	1.36	1719	2.44	1540	4.05	1275	5.18	1088	7.19	756	8.27	579						
54	.83	2092	1.55	1958	2.75	1735	4.48	1413	5.67	1192	7.72	811								
56	.86	2164	1.60	2021	2.83	1784	4.59	1446	5.78	1215	7.83	822								
60	.92	2307	1.70	2145	2.98	1880	4.79	1508	5.99	1259	8.01	842								
64	.99	2492	1.83	2307	3.19	2008	5.06	1595	6.30	1323	8.33	875								
72	1.10	2775	2.02	2548	3.47	2188	5.42	1707	6.66	1399	8.64	908								
80	1.23	3107	2.24	2828	3.81	2398	5.84	1839	7.10	1492	9.06	952								
84	1.29	3246	2.34	2943	3.94	2481	5.99	1887	7.25	1523	9.18	965								
88	1.34	3384	2.42	3056	4.06	2561	6.13	1933	7.39	1553	9.30	976								
96	1.45	3656	2.60	3277	4.31	2713	6.41	2019	7.65	1608	9.50	998								
112	1.69	4256	2.98	3757	4.83	3045	7.01	2207	8.24	1731										
120	1.79	4517	3.14	3960	5.04	3176	7.22	2275	8.44	1773										
128	1.89	4773	3.30	4155	5.24	3300	7.42	2339	8.62	1811										
144	2.09	5272	3.59	4528	5.60	3532	7.78	2452												
160	2.33	5868	3.95	4980	6.07	3828	8.28	2610												

8 DIAMETRAL PITCH NON-METALLIC 14½° PRESSURE ANGLE 1-1/4" FACE REFERENCE PAGE 24.

No. Teeth	25 RPM		50 RPM		100 RPM		200 RPM		300 RPM		600 RPM		900 RPM		1200 RPM		1800 RPM		3600 RPM	
	H.P.	Torque	H.P.	Torque	H.P.	Torque	H.P.	Torque	H.P.	Torque	H.P.	Torque	H.P.	Torque	H.P.	Torque	H.P.	Torque	H.P.	Torque
16							.56	176	.76	160	1.23	129	1.61	112	1.96	103	2.60	91	4.39	77
18							.61	192	.88	185	1.41	148	1.84	129	2.25	118	3.00	105	4.71	82
20							.74	233	.99	208	1.59	167	2.08	146	2.54	133	3.40	119	5.84	102
24							.90	283	1.19	250	1.90	200	2.50	175	3.06	160	4.13	144	7.22	126
28							1.06	334	1.38	290	2.20	231	2.91	204	3.57	187	4.86	170		

6 DIAMETRAL PITCH STEEL 14½° PRESSURE ANGLE 1-1/2" FACE REFERENCE PAGE 25.

No. Teeth	25 RPM		50 RPM		100 RPM		200 RPM		300 RPM		600 RPM		900 RPM		1200 RPM		1800 RPM		3600 RPM	
	H.P.	Torque	H.P.	Torque	H.P.	Torque	H.P.	Torque	H.P.	Torque	H.P.	Torque	H.P.	Torque	H.P.	Torque	H.P.	Torque	H.P.	Torque
11	.38	946	.74	928	1.42	893	2.64	832	3.70	778	6.20	652	8.01	561	9.37	492	11.29	395	14.19	249
12	.41	1030	.80	1008	1.54	968	2.84	896	3.97	834	6.57	691	8.41	589	9.78	514	11.69	409	14.51	254
14	.53	1340	1.04	1308	1.98	1247	3.62	1142	5.01	1053	8.12	853	10.24	717	11.77	618	13.85	485		
15	.59	1491	1.15	1452	2.19	1381	3.99	1257	5.49	1154	8.81	925	11.03	773	12.62	663	14.75	517		
16	.65	1648	1.27	1603	2.41	1519	4.37	1376	5.98	1257	9.51	999	11.83	828	13.47	708	15.65	548		
18	.78	1962	1.51	1902	2.84	1792	5.10	1606	6.92	1455	10.80	1135	13.28	930	15.00	788	17.23	603		
20	.90	2273	1.74	2196	3.26	2057	5.79	1825	7.81	1640	11.97	1258	14.57	1020	16.33	858				
21	.97	2436	1.86	2349	3.48	2194	6.15	1937	8.25	1734	12.56	1319	15.20	1065	16.99	892				
24	1.13	2860	2.18	2745	4.03	2541	7.02	2212	9.32	1958	13.87	1457	16.57	1160	18.35	964				
27	1.32	3335	2.53	3186	4.64	2924	7.97	2512	10.48	2201	15.29	1606	18.05	1264						
30	1.49	3761	2.84	3576	5.17	3255	8.76	2761	11.41	2396	16.35	1717	19.10	1338						

Ratings are based on strength calculation. Basic static strength rating, or for hand operation of above gears is approximately 3 times the 100 RPM rating.

NOTE: Ratings to right of heavy line are not recommended, as pitch line velocity exceeds 1000 feet per minute. They should be used for interpolation purposes only.

*Torque Ratings (Lb. Ins.).

Spur Gears

Approximate Horsepower and Torque* Ratings

For Class I Service (Service Factor = 1.0)

6 DIAMETRAL PITCH CAST IRON 14½° PRESSURE ANGLE 1-1/2" FACE REFERENCE PAGE 26.

No. Teeth	25 RPM		50 RPM		100 RPM		200 RPM		300 RPM		600 RPM		900 RPM		1200 RPM		1800 RPM		3600 RPM	
	H.P.	Torque	H.P.	Torque	H.P.	Torque	H.P.	Torque	H.P.	Torque	H.P.	Torque	H.P.	Torque	H.P.	Torque	H.P.	Torque	H.P.	Torque
32	.98	2470	1.86	2341	3.36	2120	5.66	1783	7.32	1539	10.38	1090	12.06	844						
33	1.01	2543	1.91	2406	3.45	2173	5.78	1821	7.46	1567	10.51	1104								
36	1.12	2813	2.10	2650	3.77	2375	6.24	1967	7.99	1678	11.09	1165								
40	1.25	3163	2.35	2962	4.17	2628	6.80	2144	8.62	1811	11.76	1235								
42	1.31	3310	2.45	3090	4.33	2728	7.02	2211	8.85	1858	11.97	1257								
48	1.51	3814	2.80	3530	4.88	3073	7.75	2441	9.64	2025	12.75	1339								
54	1.73	4364	3.18	4005	5.46	3440	8.52	2683	10.47	2199	13.59	1427								
60	1.90	4801	3.47	4371	5.88	3706	9.02	2842	10.97	2305	14.00	1471								
64	2.05	5177	3.72	4688	6.26	3944	9.50	2993	11.48	2411	14.50	1523								
66	2.11	5322	3.81	4807	6.39	4027	9.65	3040	11.62	2442	14.62	1536								
72	2.28	5750	4.09	5153	6.77	4267	10.08	3175	12.03	2528	14.94	1569								
84	2.66	6695	4.69	5912	7.60	4790	11.02	3473	12.96	2724										
96	2.98	7510	5.19	6538	8.24	5193	11.68	3680	13.56	2849										
108	3.35	8436	5.75	7246	8.97	5652	12.45	3924	14.31	3006										
120	3.65	9205	6.19	7806	9.50	5987	12.96	4083												
144	4.23	10664	7.01	8831	10.43	6571	13.79	4347												

5 DIAMETRAL PITCH STEEL 14½° PRESSURE ANGLE 1-3/4" FACE REFERENCE PAGE 26.

No. Teeth	25 RPM		50 RPM		100 RPM		200 RPM		300 RPM		600 RPM		900 RPM		1200 RPM		1800 RPM		3600 RPM	
	H.P.	Torque	H.P.	Torque	H.P.	Torque	H.P.	Torque	H.P.	Torque	H.P.	Torque	H.P.	Torque	H.P.	Torque	H.P.	Torque	H.P.	Torque
11	.63	1583	1.23	1546	2.35	1479	4.31	1360	5.99	1258	9.79	1028	12.41	869	14.33	753	16.96	594		
12	.68	1723	1.33	1680	2.54	1600	4.64	1462	6.40	1345	10.33	1085	12.99	910	14.91	783	17.49	613		
14	.89	2241	1.73	2176	3.26	2057	5.89	1855	8.04	1689	12.68	1332	15.70	1099	17.82	936	20.60	721		
15	.99	2491	1.92	2415	3.61	2275	6.47	2039	8.79	1847	13.71	1441	16.86	1181	19.05	1000	21.88	766		
16	1.09	2754	2.11	2664	3.97	2501	7.07	2227	9.56	2008	14.76	1550	18.03	1262	20.27	1065				
18	1.30	3275	2.50	3156	4.67	2942	8.22	2590	11.01	2313	16.68	1752	20.13	1410	22.46	1179				
20	1.50	3793	2.89	3640	5.35	3370	9.31	2934	12.36	2597	18.40	1933	21.98	1539	24.34	1279				

5 DIAMETRAL PITCH CAST IRON 14½° PRESSURE ANGLE 1-3/4" FACE REFERENCE PAGE 26.

No. Teeth	25 RPM		50 RPM		100 RPM		200 RPM		300 RPM		600 RPM		900 RPM		1200 RPM		1800 RPM		3600 RPM	
	H.P.	Torque	H.P.	Torque	H.P.	Torque	H.P.	Torque	H.P.	Torque	H.P.	Torque	H.P.	Torque	H.P.	Torque	H.P.	Torque	H.P.	Torque
24	1.13	2859	2.16	2723	3.95	2487	6.73	2120	8.79	1847	12.69	1333	14.88	1042						
25	1.20	3034	2.29	2885	4.17	2626	7.07	2227	9.20	1933	13.19	1385	15.41	1079						
30	1.49	3752	2.80	3534	5.03	3168	8.32	2623	10.66	2238	14.80	1554	17.00	1191						
35	1.80	4548	3.37	4246	5.95	3749	9.64	3038	12.15	2554	16.44	1727								
40	2.08	5242	3.85	4852	6.70	4224	10.65	3356	13.25	2783	17.53	1841								
45	2.36	5947	4.33	5459	7.44	4689	11.60	3657	14.27	2997	18.52	1945								
50	2.60	6543	4.73	5956	8.01	5051	12.29	3874	14.95	3142	19.08	2005								
55	2.90	7321	5.25	6612	8.79	5539	13.27	4182	15.99	3359	20.11	2112								
60	3.14	7910	5.62	7089	9.31	5870	13.86	4368	16.56	3478	20.55	2159								
70	3.65	9213	6.45	8135	10.46	6592	15.16	4779	17.84	3748										
80	4.17	10514	7.26	9153	11.54	7270	16.35	5152	18.99	3989										
100	5.03	12671	8.52	10745	13.08	8241	17.84	5620												

4 DIAMETRAL PITCH STEEL 14½° PRESSURE ANGLE 2" FACE REFERENCE PAGE 27.

No. Teeth	25 RPM		50 RPM		100 RPM		200 RPM		300 RPM		600 RPM		900 RPM		1200 RPM		1800 RPM		3600 RPM	
	H.P.	Torque	H.P.	Torque	H.P.	Torque	H.P.	Torque	H.P.	Torque	H.P.	Torque	H.P.	Torque	H.P.	Torque	H.P.	Torque	H.P.	Torque
11	1.11	2810	2.17	2730	4.10	2584	7.41	2334	10.13	2128	16.01	1682	19.86	1391	22.57	1185	26.14	915		
12	1.21	3057	2.35	2963	4.43	2792	7.94	2502	10.79	2266	16.83	1768	20.69	1449	23.37	1228	26.85	940		
14	1.58	3971	3.04	3831	5.67	3577	10.02	3158	13.46	2827	20.48	2151	24.79	1736	27.70	1455				
15	1.75	4414	3.37	4247	6.26	3948	10.98	3461	14.67	3081	22.06	2318	26.52	1857	29.50	1550				
16	1.93	4876	3.71	4680	6.87	4332	11.97	3772	15.90	3339	23.66	2485	28.26	1979	31.30	1644				
18	2.30	5794	4.39	5535	8.06	5080	13.85	4364	18.20	3824	26.56	2790	31.35	2196						
20	2.66	6703	5.06	6373	9.21	5802	15.61	4920	20.33	4271	29.13	3060	34.04	2384						
22	3.01	7579	5.69	7173	10.28	6478	17.22	5427	22.23	4670	31.33	3291	36.29	2541						

Ratings are based on strength calculation. Basic static strength rating, or for hand operation of above gears is approximately 3 times the 100 RPM rating.

NOTE: Ratings to right of heavy line are not recommended, as pitch line velocity exceeds 1000 feet per minute.

They should be used for interpolation purposes only.

*Torque Ratings (Lb. Ins.).

Approximate Horsepower and Torque* Ratings

For Class I Service (Service Factor = 1.0)

4 DIAMETRAL PITCH CAST IRON 14½° PRESSURE ANGLE 2" FACE REFERENCE PAGE 27.

No. Teeth	25 RPM		50 RPM		100 RPM		200 RPM		300 RPM		600 RPM		900 RPM		1200 RPM		1800 RPM		3600 RPM	
	H.P.	Torque	H.P.	Torque	H.P.	Torque	H.P.	Torque	H.P.	Torque	H.P.	Torque	H.P.	Torque	H.P.	Torque	H.P.	Torque	H.P.	Torque
24	2.00	5042	3.77	4750	6.75	4257	11.19	3525	14.32	3008	19.88	2089	22.84	1600						
28	2.43	6129	4.54	5723	8.02	5053	12.99	4094	16.38	3441	22.16	2328								
30	2.62	6599	4.87	6135	8.53	5378	13.69	4314	17.14	3601	22.92	2408								
32	2.86	7211	5.30	6675	9.22	5811	14.65	4616	18.22	3829	24.11	2534								
36	3.25	8187	5.96	7514	10.24	6454	15.98	5034	19.64	4126	25.49	2677								
40	3.64	9177	6.63	8354	11.24	7085	17.24	5433	20.97	4406	26.77	2812								
42	3.80	9588	6.90	8694	11.63	7328	17.69	5575	21.42	4499	27.12	2849								
44	4.04	10181	7.29	9195	12.22	7703	18.46	5816	22.24	4672	27.97	2938								
48	4.36	10999	7.82	9858	12.95	8163	19.28	6074	23.02	4837	28.58	3002								
54	4.97	12530	8.81	11104	14.35	9045	20.94	6598	24.72	5193										
56	5.13	12933	9.06	11419	14.68	9253	21.29	6708	25.04	5261										
60	5.44	13727	9.55	12034	15.32	9652	21.94	6915	25.65	5388										
64	5.86	14763	10.20	12852	16.20	10209	22.95	7233	26.66	5601										
72	6.47	16305	11.11	14005	17.33	10923	24.07	7585	27.65	5810										
80	7.18	18101	12.18	15350	18.68	11772	25.48	8029												
84	7.47	18838	12.60	15877	19.17	12079	25.93	8170												
88	7.76	19561	13.00	16387	19.63	12372	26.35	8304												
96	8.32	20970	13.78	17365	20.50	12922	27.13	8548												



3 DIAMETRAL PITCH STEEL 14½° PRESSURE ANGLE 3" FACE REFERENCE PAGE 27.

No. Teeth	25 RPM		50 RPM		100 RPM		200 RPM		300 RPM		600 RPM		900 RPM		1200 RPM		1800 RPM		3600 RPM	
	H.P.	Torque	H.P.	Torque	H.P.	Torque	H.P.	Torque	H.P.	Torque	H.P.	Torque	H.P.	Torque	H.P.	Torque	H.P.	Torque	H.P.	Torque
11	2.94	7421	5.67	7146	10.56	6652	18.55	5846	24.82	5213	37.47	3936	45.15	3162	50.30	2642				
12	3.20	8067	6.14	7743	11.37	7167	19.80	6239	26.30	5524	39.14	4111	46.74	3273	51.78	2719				
14	4.15	10462	7.92	9979	14.49	9134	24.79	7812	32.48	6824	47.09	4947	55.40	3880						
15	4.61	11618	8.76	11046	15.96	10056	27.06	8528	35.24	7403	50.49	5304	59.01	4132						
16	5.09	12825	9.64	12156	17.47	11008	29.38	9259	38.03	7989	53.89	5661	62.60	4383						
18	6.03	15214	11.37	14333	20.38	12845	33.75	10637	43.20	9076	60.00	6303	68.93	4827						
20	6.97	17570	13.05	16454	23.16	14599	37.80	11913	47.89	10062	65.33	6863								
21	7.46	18795	13.92	17549	24.59	15495	39.84	12556	50.24	10554	67.96	7139								

3 DIAMETRAL PITCH CAST IRON 14½° PRESSURE ANGLE 3" FACE REFERENCE PAGE 27.

No. Teeth	25 RPM		50 RPM		100 RPM		200 RPM		300 RPM		600 RPM		900 RPM		1200 RPM		1800 RPM		3600 RPM	
	H.P.	Torque	H.P.	Torque	H.P.	Torque	H.P.	Torque	H.P.	Torque	H.P.	Torque	H.P.	Torque	H.P.	Torque	H.P.	Torque	H.P.	Torque
24	5.23	13175	9.67	12195	16.84	10617	26.76	8433	33.30	6995	44.05	4627	22.84	1600						
30	6.81	17164	12.40	15626	21.03	13251	32.25	10162	39.23	8241	50.07	5259								
36	8.41	21199	15.07	18998	24.96	15732	37.15	11707	44.37	9322	55.08	5786								
42	9.81	24721	17.32	21828	28.06	17687	40.69	12822	47.87	10056										
48	11.20	28241	19.50	24586	30.99	19530	43.91	13838	51.00	10715										
54	12.71	32043	21.83	27523	34.06	21466	47.30	14906	54.35	11417										
60	13.87	34965	23.52	29651	36.08	22740	49.22	15509												
72	16.35	41223	27.08	34136	40.30	25402	53.32	16803												
84	18.76	47293	30.40	38322	44.08	27782	56.87	17923												
96	20.75	52300	32.96	41545	46.71	29437	59.02	18597												
108	22.99	57968	35.87	45212	49.81	31395	61.84	19486												

Ratings are based on strength calculation. Basic static strength rating, or for hand operation of above gears is approximately 3 times the 100 RPM rating.

NOTE: Ratings to right of heavy line are not recommended, as pitch line velocity exceeds 1000 feet per minute. They should be used for interpolation purposes only.

*Torque Ratings (Lb. Ins.).

Spur Gears

Approximate Horsepower and Torque* Ratings

For Class I Service (Service Factor = 1.0)

20 DIAMETRAL PITCH STEEL 20° PRESSURE ANGLE 1/2" FACE REFERENCE PAGE 42.

No. Teeth	25 RPM		50 RPM		100 RPM		200 RPM		300 RPM		600 RPM		900 RPM		1200 RPM		1800 RPM		3600 RPM	
	H.P.	Torque	H.P.	Torque	H.P.	Torque	H.P.	Torque	H.P.	Torque	H.P.	Torque	H.P.	Torque	H.P.	Torque	H.P.	Torque	H.P.	Torque
12	.01	36.5	.03	36.3	.06	35.8	.11	34.9	.16	34.1	.30	31.8	.42	29.7	.53	28.0	.71	25.0	1.08	18.9
14	.02	48.0	.04	47.7	.07	46.9	.14	45.6	.21	44.3	.39	40.9	.54	37.9	.67	35.4	.89	31.2	1.32	23.0
15	.02	53.8	.04	53.3	.08	52.5	.16	50.9	.23	49.3	.43	45.3	.60	41.9	.74	38.9	.97	34.1	1.42	24.9
16	.02	58.6	.05	58.1	.09	57.1	.18	55.2	.25	53.5	.46	48.8	.64	44.9	.79	41.6	1.04	36.3	1.49	26.2
18	.03	68.6	.05	67.9	.11	66.7	.20	64.2	.29	62.0	.53	56.1	.73	51.2	.90	47.1	1.16	40.6	1.64	28.7
20	.03	79.2	.06	78.4	.12	76.8	.23	73.7	.34	70.8	.60	63.5	.82	57.5	1.00	52.6	1.28	44.9	1.78	31.2
24	.04	99.5	.08	98.3	.15	95.8	.29	91.3	.41	87.1	.73	76.7	.98	68.5	1.18	61.9	1.48	51.9	2.00	34.9
25	.04	105	.08	103	.16	101	.30	95.6	.43	91.1	.76	79.9	1.02	71.1	1.22	64.1	1.53	53.5	2.04	35.8
30	.05	132	.10	130	.20	126	.38	119	.53	112	.92	96.4	1.21	84.5	1.43	75.2	1.76	61.6	2.28	40.0
35	.07	165	.13	162	.25	156	.46	145	.65	136	1.09	115	1.42	99.4	1.67	87.5	2.02	70.6	2.55	44.7
40	.08	194	.15	190	.29	182	.53	168	.75	157	1.24	130	1.58	111	1.84	96.6	2.20	77.0	2.73	47.8
45	.09	224	.17	219	.33	209	.61	192	.84	177	1.38	145	1.74	122	2.01	105	2.37	83.0		
50	.10	248	.19	242	.37	230	.66	210	.92	192	1.47	154	1.84	129	2.10	111	2.46	86.1		
60	.12	306	.24	296	.44	279	.79	250	1.08	227	1.68	177	2.07	145	2.34	123	2.69	94.0		
70	.14	365	.28	352	.52	329	.92	291	1.24	260	1.88	198	2.28	160	2.55	134				

20 DIAMETRAL PITCH CAST IRON 20° PRESSURE ANGLE 1/2" FACE REFERENCE PAGE 42.

No. Teeth	25 RPM		50 RPM		100 RPM		200 RPM		300 RPM		600 RPM		900 RPM		1200 RPM		1800 RPM		3600 RPM	
	H.P.	Torque	H.P.	Torque	H.P.	Torque	H.P.	Torque	H.P.	Torque	H.P.	Torque	H.P.	Torque	H.P.	Torque	H.P.	Torque	H.P.	Torque
80	.10	256	.20	246	.36	228	.63	198	.84	176	1.24	131	1.49	104	1.65	86.5				
84	.11	269	.20	257	.38	237	.65	206	.86	181	1.27	134	1.51	106	1.67	87.8				
90	.11	287	.22	274	.40	252	.69	216	.90	189	1.32	138	1.55	109	1.71	89.7				
100	.13	317	.24	302	.44	275	.74	233	.96	202	1.38	145	1.61	113	1.76	92.4				
120	.15	387	.29	365	.52	327	.86	271	1.10	231	1.53	161	1.76	123						
140	.18	447	.33	418	.59	369	.95	299	1.20	251	1.62	170	1.83	128						
160	.21	520	.38	481	.66	419	1.06	333	1.31	276	1.74	183								
180	.23	579	.42	532	.72	457	1.13	356	1.39	292	1.80	189								
200	.25	637	.46	580	.78	492	1.20	377	1.46	306	1.86	195								

16 DIAMETRAL PITCH STEEL 20° PRESSURE ANGLE 3/4" FACE REFERENCE PAGE 43.

No. Teeth	25 RPM		50 RPM		100 RPM		200 RPM		300 RPM		600 RPM		900 RPM		1200 RPM		1800 RPM		3600 RPM	
	H.P.	Torque	H.P.	Torque	H.P.	Torque	H.P.	Torque	H.P.	Torque	H.P.	Torque	H.P.	Torque	H.P.	Torque	H.P.	Torque	H.P.	Torque
12	.03	85.5	.07	84.7	.13	83.4	.26	80.9	.37	78.4	.69	72.0	.95	66.5	1.18	61.8	1.55	54.2	2.26	39.5
14	.04	112	.09	111	.17	109	.33	105	.48	102	.88	92.2	1.20	84.4	1.48	77.7	1.92	67.2	2.73	47.7
15	.05	126	.10	124	.19	122	.37	117	.54	113	.97	102	1.33	92.8	1.62	85.2	2.09	73.1	2.93	51.3
16	.05	136	.11	135	.21	133	.40	127	.58	122	1.04	110	1.42	99.4	1.73	90.8	2.21	77.5	3.07	53.8
18	.06	160	.13	158	.25	155	.47	148	.67	142	1.19	125	1.61	113	1.94	102	2.46	86.2	3.35	58.6
20	.07	185	.14	183	.28	178	.54	169	.77	161	1.35	141	1.80	126	2.16	113	2.70	94.7	3.62	63.3
24	.09	233	.18	229	.35	222	.66	209	.94	198	1.62	170	2.12	149	2.52	132	3.10	108	4.02	70.4
28	.11	283	.22	278	.43	268	.79	250	1.12	235	1.88	198	2.44	171	2.87	151	3.47	122	4.40	77.0
30	.12	308	.24	302	.46	291	.86	270	1.20	253	2.01	211	2.59	181	3.02	159	3.63	127	4.55	79.7
32	.13	340	.26	333	.51	320	.94	296	1.31	275	2.17	228	2.78	195	3.23	170	3.86	135	4.79	83.9
36	.16	395	.31	385	.58	368	1.07	338	1.49	312	2.42	254	3.06	215	3.53	186	4.17	146	5.09	89.1
40	.18	452	.35	440	.66	418	1.21	381	1.66	349	2.67	280	3.34	234	3.82	201	4.47	156	5.37	94.1
48	.22	556	.43	539	.81	508	1.44	455	1.96	412	3.06	322	3.76	264	4.25	223	4.88	171		
56	.26	665	.51	642	.95	599	1.68	529	2.25	474	3.43	360	4.15	291	4.64	244				
60	.28	711	.54	684	1.01	636	1.77	557	2.36	496	3.55	373	4.27	299	4.75	250				
64	.31	779	.59	748	1.10	692	1.91	602	2.54	533	3.78	397	4.51	316	5.00	263				
72	.35	872	.66	833	1.21	764	2.08	656	2.74	575	4.00	420	4.72	330						
80	.39	991	.75	943	1.36	858	2.31	728	3.01	632	4.31	453	5.04	353						

Ratings are based on strength calculation. Basic static strength rating, or for hand operation of above gears is approximately 3 times the 100 RPM rating.

NOTE: Ratings to right of heavy line are not recommended, as pitch line velocity exceeds 1000 feet per minute. They should be used for interpolation purposes only.

*Torque Ratings (Lb. Ins.).

Approximate Horsepower and Torque* Ratings

For Class I Service (Service Factor = 1.0)

16 DIAMETRAL PITCH CAST IRON 20° PRESSURE ANGLE 3/4" FACE REFERENCE PAGE 43.

No. Teeth	25 RPM		50 RPM		100 RPM		200 RPM		300 RPM		600 RPM		900 RPM		1200 RPM		1800 RPM		3600 RPM	
	H.P.	Torque	H.P.	Torque	H.P.	Torque	H.P.	Torque	H.P.	Torque	H.P.	Torque	H.P.	Torque	H.P.	Torque	H.P.	Torque	H.P.	Torque
96	.28	707	.53	666	.95	597	1.57	494	2.01	421	2.79	293	3.20	224						
128	.38	949	.70	879	1.21	765	1.93	608	2.40	504	3.17	333	3.56	249						
144	.42	1057	.77	970	1.32	833	2.06	650	2.54	533	3.29	346								
160	.47	1195	.86	1088	1.46	923	2.25	707	2.73	574	3.49	366								
192	.56	1406	1.00	1260	1.66	1044	2.46	777	2.94	618	3.65	384								

A

12 DIAMETRAL PITCH STEEL 20° PRESSURE ANGLE 1" FACE REFERENCE PAGE 43.

No. Teeth	25 RPM		50 RPM		100 RPM		200 RPM		300 RPM		600 RPM		900 RPM		1200 RPM		1800 RPM		3600 RPM	
	H.P.	Torque	H.P.	Torque	H.P.	Torque	H.P.	Torque	H.P.	Torque	H.P.	Torque	H.P.	Torque	H.P.	Torque	H.P.	Torque	H.P.	Torque
12	.08	202	.16	200	.31	196	.60	188	.86	181	1.54	162	2.09	147	2.55	134	3.27	114	4.53	79.4
13	.09	233	.18	230	.36	225	.68	215	.98	206	1.75	183	2.36	165	2.86	150	3.63	127	4.97	87.1
14	.11	265	.21	262	.41	256	.77	244	1.11	233	1.96	206	2.63	184	3.18	167	4.00	140	5.42	94.8
15	.12	297	.23	293	.45	285	.86	271	1.23	259	2.16	227	2.88	202	3.46	182	4.34	152	5.80	102
16	.13	323	.25	319	.49	310	.93	294	1.33	279	2.31	243	3.07	215	3.68	193	4.58	160	6.05	106
18	.15	379	.30	373	.57	361	1.08	340	1.53	322	2.63	276	3.46	242	4.10	215	5.04	177	6.55	115
20	.17	437	.34	429	.66	415	1.23	389	1.74	365	2.95	310	3.84	269	4.52	238	5.50	193	7.02	123
21	.19	468	.36	459	.70	443	1.31	413	1.84	388	3.11	327	4.03	282	4.73	249	5.73	201	7.26	127
24	.22	548	.43	537	.82	515	1.51	477	2.11	444	3.50	368	4.48	314	5.21	274	6.22	218	7.72	135
28	.26	667	.52	651	.99	621	1.80	568	2.49	524	4.04	425	5.10	357	5.86	308	6.89	241		
30	.29	720	.56	707	1.07	673	1.94	612	2.68	562	4.29	451	5.37	376	6.15	323	7.19	252		
36	.37	928	.71	899	1.34	847	2.41	759	3.27	688	5.11	537	6.28	440	7.09	373	8.15	285		
42	.44	1112	.85	1073	1.59	1001	2.81	884	3.77	792	5.73	602	6.94	486	7.76	407				
48	.52	1304	.99	1252	1.84	1159	3.20	1009	4.25	893	6.33	665	7.56	529	8.37	440				
54	.60	1505	1.14	1437	2.09	1319	3.60	1133	4.73	993	6.90	724	8.14	570						

12 DIAMETRAL PITCH CAST IRON 20° PRESSURE ANGLE 1" FACE REFERENCE PAGE 44.

No. Teeth	25 RPM		50 RPM		100 RPM		200 RPM		300 RPM		600 RPM		900 RPM		1200 RPM		1800 RPM		3600 RPM	
	H.P.	Torque	H.P.	Torque	H.P.	Torque	H.P.	Torque	H.P.	Torque	H.P.	Torque	H.P.	Torque	H.P.	Torque	H.P.	Torque	H.P.	Torque
60	.40	998	.75	949	1.37	864	2.32	733	3.03	636	4.34	456	5.07	355						
66	.45	1125	.84	1064	1.53	961	2.56	805	3.30	693	4.65	488	5.38	377						
72	.48	1221	.91	1150	1.64	1031	2.71	853	3.47	728	4.81	506	5.53	387						
84	.58	1450	1.07	1354	1.90	1196	3.07	969	3.88	814	5.24	551								
96	.65	1641	1.21	1519	2.10	1322	3.33	1050	4.15	871	5.49	576								
108	.75	1879	1.37	1725	2.35	1482	3.67	1156	4.51	947	5.85	615								
120	.82	2068	1.49	1882	2.53	1596	3.88	1224	4.73	993	6.03	634								
132	.89	2252	1.61	2034	2.70	1704	4.08	1287	4.92	1033	6.19	650								
144	.97	2433	1.73	2181	2.87	1806	4.26	1344	5.09	1070	6.32	664								
168	1.13	2861	2.00	2526	3.25	2047	4.71	1484	5.54	1164										
192	1.27	3209	2.22	2794	3.52	2219	4.99	1573	5.80	1218										
216	1.41	3545	2.42	3045	3.77	2375	5.23	1649	6.01	1263										

Ratings are based on strength calculation. Basic static strength rating, or for hand operation of above gears is approximately 3 times the 100 RPM rating.

NOTE: Ratings to right of heavy line are not recommended, as pitch line velocity exceeds 1000 feet per minute. They should be used for interpolation purposes only.

*Torque Ratings (Lb. Ins.).

Spur Gears

Approximate Horsepower and Torque* Ratings

For Class I Service (Service Factor = 1.0)

10 DIAMETRAL PITCH STEEL 20° PRESSURE ANGLE 1-1/4" FACE REFERENCE PAGE 44.

No. Teeth	25 RPM		50 RPM		100 RPM		200 RPM		300 RPM		600 RPM		900 RPM		1200 RPM		1800 RPM		3600 RPM	
	H.P.	Torque	H.P.	Torque	H.P.	Torque	H.P.	Torque	H.P.	Torque	H.P.	Torque	H.P.	Torque	H.P.	Torque	H.P.	Torque	H.P.	Torque
12	.14	363	.28	358	.55	349	1.06	333	1.51	318	2.66	280	3.57	250	4.30	226	5.40	189	7.27	127
14	.19	477	.37	469	.72	456	1.37	431	1.95	409	3.37	354	4.46	312	5.31	279	6.58	230	8.63	151
15	.21	533	.42	525	.81	509	1.52	479	2.16	453	3.70	389	4.87	341	5.78	303	7.10	249	9.22	161
16	.23	580	.45	571	.88	552	1.64	518	2.32	488	3.96	416	5.18	363	6.12	321	7.47	262	9.60	168
18	.27	679	.53	667	1.02	642	1.90	599	2.67	561	4.48	471	5.79	406	6.79	356	8.19	287	10.33	181
20	.31	784	.61	768	1.17	737	2.16	682	3.02	635	5.00	526	6.41	449	7.45	391	8.90	311	11.04	193
24	.39	983	.76	958	1.45	913	2.65	834	3.65	767	5.89	619	7.41	519	8.50	447	9.98	349		
25	.41	1032	.80	1005	1.52	956	2.76	870	3.80	799	6.10	641	7.64	535	8.74	459	10.21	358		
28	.47	1195	.92	1161	1.74	1097	3.14	990	4.29	901	6.76	710	8.37	586	9.50	499	10.99	385		
30	.52	1300	1.00	1260	1.88	1187	3.38	1064	4.59	964	7.16	752	8.80	616	9.94	522	11.42	400		
35	.64	1615	1.24	1558	2.31	1454	4.08	1284	5.47	1150	8.33	875	10.08	706	11.27	592				
40	.75	1896	1.44	1820	2.67	1685	4.65	1467	6.18	1299	9.20	966	10.99	770	12.17	639				
45	.87	2190	1.66	2092	3.05	1920	5.23	1649	6.88	1445	10.04	1054	11.85	830						
48	.92	2328	1.76	2218	3.21	2026	5.48	1727	7.16	1504	10.33	1085	12.12	849						
50	.96	2420	1.83	2301	3.32	2095	5.64	1777	7.34	1542	10.52	1105	12.29	861						

10 DIAMETRAL PITCH CAST IRON 20° PRESSURE ANGLE 1-1/4" FACE REFERENCE PAGE 44.

No. Teeth	25 RPM		50 RPM		100 RPM		200 RPM		300 RPM		600 RPM		900 RPM		1200 RPM		1800 RPM		3600 RPM	
	H.P.	Torque	H.P.	Torque	H.P.	Torque	H.P.	Torque	H.P.	Torque	H.P.	Torque	H.P.	Torque	H.P.	Torque	H.P.	Torque	H.P.	Torque
55	.65	1638	1.23	1550	2.22	1400	3.72	1173	4.80	1009	6.77	711	7.84	549						
60	.71	1778	1.33	1675	2.38	1501	3.94	1243	5.05	1061	7.01	737	8.06	564						
70	.84	2114	1.57	1974	2.77	1743	4.48	1413	5.65	1187	7.65	803								
80	.98	2462	1.81	2279	3.15	1984	5.00	1576	6.22	1307	8.23	865								
90	1.09	2742	2.00	2517	3.43	2162	5.35	1686	6.58	1382	8.54	897								
100	1.20	3016	2.18	2746	3.70	2329	5.67	1786	6.89	1448	8.80	924								
120	1.45	3650	2.59	3271	4.30	2709	6.40	2016	7.64	1605	9.48	996								
140	1.66	4177	2.93	3688	4.74	2989	6.88	2167	8.09	1699										
160	1.91	4814	3.32	4191	5.28	3329	7.49	2359	8.69	1826										
200	2.30	5802	3.90	4920	5.99	3773	8.17	2573												

8 DIAMETRAL PITCH STEEL 20° PRESSURE ANGLE 1-1/2" FACE REFERENCE PAGE 45.

No. Teeth	25 RPM		50 RPM		100 RPM		200 RPM		300 RPM		600 RPM		900 RPM		1200 RPM		1800 RPM		3600 RPM	
	H.P.	Torque	H.P.	Torque	H.P.	Torque	H.P.	Torque	H.P.	Torque	H.P.	Torque	H.P.	Torque	H.P.	Torque	H.P.	Torque	H.P.	Torque
12	.27	678	.53	667	1.03	647	1.93	609	2.74	576	4.71	495	6.19	434	7.35	386	9.03	316	11.72	205
14	.35	890	.69	874	1.34	843	2.50	787	3.51	738	5.92	622	7.68	537	9.01	473	10.91	382	13.81	242
15	.39	996	.77	976	1.49	939	2.77	873	3.88	816	6.49	681	8.35	585	9.76	513	11.73	411	14.70	257
16	.43	1084	.84	1061	1.62	1018	2.99	943	4.18	877	6.92	727	8.85	620	10.30	541	12.30	431		
18	.50	1268	.98	1238	1.88	1183	3.44	1086	4.77	1003	7.78	817	9.84	689	11.35	596	13.40	469		
20	.58	1462	1.13	1424	2.15	1354	3.91	1233	5.39	1131	8.64	908	10.82	758	12.38	650	14.47	507		
22	.66	1651	1.27	1604	2.41	1518	4.35	1371	5.95	1250	9.41	989	11.67	817	13.27	698	15.36	538		
24	.73	1831	1.41	1775	2.65	1672	4.75	1498	6.46	1357	10.08	1059	12.39	868	14.00	735	16.08	563		
28	.88	2224	1.70	2145	3.18	2003	5.61	1768	7.54	1583	11.47	1204	13.88	972	15.51	815				
32	1.06	2664	2.03	2557	3.76	2367	6.54	2060	8.68	1824	12.92	1358	15.44	1081	17.10	898				
36	1.22	3082	2.34	2944	4.29	2703	7.37	2321	9.68	2034	14.13	1484	16.68	1168						

Ratings are based on strength calculation. Basic static strength rating, or for hand operation of above gears is approximately 3 times the 100 RPM rating.

NOTE: Ratings to right of heavy line are not recommended, as pitch line velocity exceeds 1000 feet per minute. They should be used for interpolation purposes only.

*Torque Ratings (Lb. Ins.).

Spur Gears

Approximate Horsepower and Torque* Ratings

For Class I Service (Service Factor = 1.0)

8 DIAMETRAL PITCH CAST IRON

20° PRESSURE ANGLE 1-1/2" FACE

REFERENCE PAGE 45.

No. Teeth	25 RPM		50 RPM		100 RPM		200 RPM		300 RPM		600 RPM		900 RPM		1200 RPM		1800 RPM		3600 RPM	
	H.P.	Torque	H.P.	Torque	H.P.	Torque	H.P.	Torque	H.P.	Torque	H.P.	Torque	H.P.	Torque	H.P.	Torque	H.P.	Torque	H.P.	Torque
40	.84	2111	1.59	2007	2.90	1928	4.92	1550	6.40	1345	9.18	964	10.72	751						
44	.95	2384	1.79	2256	3.23	2038	5.42	1707	6.99	1469	9.86	1035	11.41	799						
48	1.03	2587	1.93	2437	3.47	2184	5.74	1809	7.35	1543	10.20	1072	11.72	821						
56	1.22	3080	2.28	2876	4.03	2539	6.53	2057	8.23	1729	11.14	1170								
60	1.30	3283	2.42	3052	4.25	2676	6.81	2146	8.53	1792	11.40	1198								
64	1.42	3588	2.64	3322	4.59	2892	7.29	2297	9.07	1905	12.00	1260								
72	1.59	3997	2.91	3669	5.00	3151	7.80	2458	9.59	2014	12.44	1307								
80	1.79	4525	3.27	4119	5.54	3493	8.50	2679	10.34	2173	13.20	1386								
88	1.96	4929	3.53	4451	5.92	3729	8.93	2816	10.76	2262	13.54	1422								
96	2.11	5325	3.79	4772	6.27	3952	9.33	2941	11.15	2341	13.83	1453								
112	2.49	6266	4.39	5533	7.11	4483	10.31	3250	12.13	2549										
120	2.64	6651	4.63	5830	7.42	4677	10.63	3351	12.43	2610										
128	2.79	7028	4.85	6118	7.71	4860	10.93	3444	12.69	2667										

A

6 DIAMETRAL PITCH STEEL

20° PRESSURE ANGLE 2" FACE

REFERENCE PAGE 45 & 46.

No. Teeth	25 RPM		50 RPM		100 RPM		200 RPM		300 RPM		600 RPM		900 RPM		1200 RPM		1800 RPM		3600 RPM	
	H.P.	Torque	H.P.	Torque	H.P.	Torque	H.P.	Torque	H.P.	Torque	H.P.	Torque	H.P.	Torque	H.P.	Torque	H.P.	Torque	H.P.	Torque
12	.63	1559	1.24	1565	2.38	1502	4.41	1391	6.16	1294	10.20	1072	13.06	915	15.19	798	18.14	635		
14	.83	2097	1.62	2046	3.10	1951	5.67	1786	7.84	1647	12.70	1334	16.02	1122	18.42	967	21.67	759		
15	.93	2345	1.81	2284	3.45	2171	6.27	1977	8.64	1814	13.85	1455	17.35	1215	19.85	1043	23.20	812		
16	1.01	2551	1.97	2480	3.73	2351	6.76	2129	9.26	1945	14.71	1545	18.30	1282	20.85	1095	24.21	848		
18	1.18	2981	2.29	2889	4.32	2722	7.74	2440	10.52	2210	16.41	1724	20.18	1413	22.79	1197	26.18	917		
21	1.46	3671	2.81	3541	5.25	3306	9.26	2919	12.44	2613	18.93	1988	22.91	1605	25.61	1345				
24	1.70	4294	3.27	4122	6.05	3815	10.54	3322	14.00	2941	20.83	2188	24.88	1743	27.56	1448				
27	1.98	4986	3.78	4763	6.94	4372	11.92	3755	15.66	3241	22.85	2400	26.98	1889						
30	2.25	5660	4.27	5381	7.77	4899	13.18	4155	17.17	3607	24.60	2584	28.75	2013						

6 DIAMETRAL PITCH CAST IRON

20° PRESSURE ANGLE 2" FACE

REFERENCE PAGE 46.

No. Teeth	25 RPM		50 RPM		100 RPM		200 RPM		300 RPM		600 RPM		900 RPM		1200 RPM		1800 RPM		3600 RPM	
	H.P.	Torque	H.P.	Torque	H.P.	Torque	H.P.	Torque	H.P.	Torque	H.P.	Torque	H.P.	Torque	H.P.	Torque	H.P.	Torque	H.P.	Torque
33	1.53	3847	2.89	3641	5.22	3288	8.74	2755	11.28	2370	15.90	1670	18.42	1290						
36	1.71	4316	3.23	4066	5.78	3644	9.58	3018	12.26	2575	17.02	1788	19.56	1370						
42	2.04	5148	3.81	4807	6.73	4244	10.91	3439	13.76	2891	18.62	1955								
48	2.38	6009	4.41	5563	7.68	4843	12.21	3847	15.19	3191	20.09	2111								
54	2.74	6899	5.02	6333	8.63	5440	13.46	4243	16.55	3477	21.48	2256								
60	3.01	7591	5.48	6910	9.30	5860	14.26	4494	17.35	3645	22.14	2326								
66	3.38	8515	6.10	7691	10.22	6443	15.44	4864	18.60	3907	23.39	2457								
72	3.65	9200	6.54	8245	10.83	6827	16.12	5080	19.26	4045	23.90	2511								
84	4.30	10835	7.59	9566	12.30	7752	17.83	5620	20.98	4407										
96	4.82	12152	8.39	10579	13.33	8404	18.90	5955	21.95	4611										
108	5.47	13800	9.40	11583	14.67	9245	20.37	6420	23.41	4917										
120	5.97	15059	10.13	12770	15.54	9793	21.20	6680												

Ratings are based on strength calculation. Basic static strength rating, or for hand operation of above gears is approximately 3 times the 100 RPM rating.

NOTE: Ratings to right of heavy line are not recommended, as pitch line velocity exceeds 1000 feet per minute. They should be used for interpolation purposes only.

*Torque Ratings (Lb. Ins.).

Spur Gears

Approximate Horsepower and Torque* Ratings

For Class I Service (Service Factor = 1.0)

5 DIAMETRAL PITCH STEEL 20° PRESSURE ANGLE 2-1/2" FACE REFERENCE PAGE 46.

No. Teeth	25 RPM		50 RPM		100 RPM		200 RPM		300 RPM		600 RPM		900 RPM		1200 RPM		1800 RPM		3600 RPM	
	H.P.	Torque	H.P.	Torque	H.P.	Torque	H.P.	Torque	H.P.	Torque	H.P.	Torque	H.P.	Torque	H.P.	Torque	H.P.	Torque	H.P.	Torque
12	1.14	2865	2.22	2794	4.22	2662	7.71	2431	10.65	2237	17.19	1805	21.61	1513	24.80	1302	29.09	1019		
14	1.49	3756	2.89	3647	5.47	3449	9.87	3110	13.48	2832	21.25	2233	26.31	1843	29.87	1569	34.53	1209		
15	1.67	4198	3.23	4069	6.08	3833	10.90	3435	14.81	3112	23.11	2427	28.41	1990	32.09	1686	36.87	1291		
16	1.81	4565	3.50	4416	6.58	4146	11.72	3693	15.85	3329	24.47	2570	29.89	2093	33.61	1765				
18	2.12	5332	4.08	5138	7.60	4789	13.38	4216	17.92	3766	27.15	2852	32.77	2295	36.56	1920				
20	2.44	6141	4.68	5894	8.66	5456	15.07	4750	20.02	4205	29.79	3129	35.58	2492	39.41	2070				

5 DIAMETRAL PITCH CAST IRON 20° PRESSURE ANGLE 2-1/2" FACE REFERENCE PAGE 46.

No. Teeth	25 RPM		50 RPM		100 RPM		200 RPM		300 RPM		600 RPM		900 RPM		1200 RPM		1800 RPM		3600 RPM	
	H.P.	Torque	H.P.	Torque	H.P.	Torque	H.P.	Torque	H.P.	Torque	H.P.	Torque	H.P.	Torque	H.P.	Torque	H.P.	Torque	H.P.	Torque
24	1.82	4599	3.48	4381	6.35	4002	10.82	3411	14.15	2972	20.41	2144	23.95	1677						
25	1.91	4826	3.64	4588	6.63	4177	11.24	3542	14.64	3075	20.97	2203	24.51	1716						
28	2.21	5571	4.18	5267	7.54	4750	12.60	3970	16.23	3410	22.81	2396	26.37	1847						
30	2.40	6050	4.52	5700	8.10	5108	13.42	4230	17.18	3609	23.86	2506	27.41	1920						
35	2.97	7477	5.54	6982	9.78	6164	15.85	4995	19.98	4199	27.04	2840								
40	3.47	8737	6.42	8087	11.17	7040	17.75	5593	22.08	4639	29.21	3068								
45	3.98	10040	7.31	9216	12.56	7916	19.59	6174	24.09	5060	31.26	3284								
50	4.38	11046	7.98	10056	13.53	8528	20.75	6540	25.25	5304	32.22	3384								
60	5.32	13399	9.53	12008	15.78	9944	23.48	7400	28.05	5892	34.81	3657								
70	6.27	15794	11.06	13945	17.93	11300	26.00	8192	30.58	6425										
80	7.23	18229	12.59	15869	20.00	12605	28.34	8932	32.92	6916										
100	8.71	21969	14.78	18630	22.67	14288	30.92	9745												
110	9.68	24409	16.22	20449	24.50	15439	32.88	10362												
120	10.38	26168	17.19	21669	25.58	16125	33.85	10666												
140	11.70	29508	18.97	23910	27.50	17334	35.49	11182												
160	13.30	33526	21.13	26631	29.94	18870	37.83	11921												
180	14.49	36534	22.61	28495	31.40	19787	38.97	12281												

Ratings are based on strength calculation. Basic static strength rating, or for hand operation of above gears is approximately 3 times the 100 RPM rating.

NOTE: Ratings to right of heavy line are not recommended, as pitch line velocity exceeds 1000 feet per minute. They should be used for interpolation purposes only.

*Torque Ratings (Lb. Ins.).

Gear Gauge Set



14-1/2° and 20° Pressure Angles

This handy, steel gear gauge set consists of 16 leaves — 24 gauges — to measure both 14-1/2° and 20° Pressure Angle tooth form, in diametral pitch sizes 64, 48, 32, 24, 20, 16, 12, 10, 8, 6, 5 and 4. Pitch sizes 8, 6, 5 and 4 both 14-1/2° and 20° are cut on individual leaves. Pitch sizes 64 through 10 inclusive, have both 14-1/2° and 20° Pressure Angles on a single leaf.

SOLD ONLY AS A COMPLETE SET

ORDER BY CATALOG NUMBER OR ITEM CODE

Catalog Number	Item Code
Gear Gauge	06000